

A PRELIMINARY STUDY OF ADAPTATION AND INHIBITION  
OF REFLEX CLAW OPENING IN THE CRAB  
POTAMON PHILATUS (Milne Edwards)

Thesis submitted for the degree of  
Master of Science

B. M. H. NISH

1956

Zoology Department,  
Rhodes University.

COPY

In accordance with the Regulation G.21, I include the following information as to the extent to which this thesis represents my own work.

The original problem for this research was suggested by my supervisor, Professor D.W. Ewer. The entire research work embodied in this thesis is my own work, and was done under the direction of my supervisor. I received some initial guidance from Dr. Ripley, in the technique of separating single nerve axons, and in building an electronic stimulator. In assembling the experimental apparatus, I obtained technical advice and assistance from members of the Department of Physics, who made a few fittings for the apparatus, such as recording lever springs. In the photographic reproduction of the text figures, I received assistance and facilities from members of the department of Zoology in the University of Natal. The manuscript of the present thesis was prepared by myself, with some helpful criticism by my supervisor and by the Professor of Zoology of the University of Natal.

Yours faithfully,

B.M.H. BUSH

## RESUME.

The only recorded experimental attempt to determine the functional, biological significance of peripheral inhibition in the Crustacea is that of Hoffmann (1914). From a series of experiments on Astacus fluviatilis L., involving transsection of the opener inhibitor and motor axons of the cheliped, he concluded that the opener inhibitor axon of the claw responded to prolonged or repeated sensory stimulation by transmitting inhibitory impulses to the opener muscle, the peripheral inhibition thus evoked causing adaptation of the reflex opening responses of the claw to the sensory stimulation. This suggests that there may be (1) a very high degree of peripheral control of (a) the reactions of the animal to external stimuli, and perhaps also to proprioceptive stimuli, and therefore (b) of the behaviour of the animal; and (2) a correspondingly high degree of independence of this behaviour from central nervous control. It is therefore of importance to discover whether, in fact, this conclusion is valid for Astacus and other Decapod Crustacea, and if so, then to what extent the adaptation is peripherally controlled.

A preliminary attempt has been made to repeat these experiments of Hoffmann, using Potamon perlatum (M.Edw.). Experiments in which mechanical sensory stimulation was used to evoke reflex claw opening indicated that this conclusion is not applicable to P.perlatum. The adaptation of the mechanical claw opening responses which occurred with repeated sensory stimulation was not affected by transsection of either the specific opener inhibitor axon or the common inhibitor axon of the claw. It was evidently mainly due to sensory adaptation when the sensory stimuli were heavy, and to centrally controlled adaptation when the sensory stimuli were light. The significance of these results is discussed. Other effects observed during the course of the work, of electrical "sensory" stimulation, and of cerebral ganglion elimination, are also described, and discussed in relation to the present problem.

## CONTENTS.

1.0 INTRODUCTION.	Page 1
2.0 MATERIAL AND APPARATUS.	4
2.1 Animals.	4
2.11 Collection of animals.	
2.12 Keeping in the laboratory.	
2.2 Physiological saline solution for experimental work.	5
2.3 Dissecting apparatus.	7
2.31 Microscopes.	
2.32 Lamp.	
2.33 Needles.	
2.4 Stimulating apparatus.	9
2.41 Mechanical hammer stimulator.	
2.42 Electronic square-wave stimulator.	
2.43 Electrodes.	
2.5 Recording apparatus.	15
2.51 Kymograph, signal markers, time marker.	
2.52 Recording levers.	
3.0 ANATOMY OF THE CHELIPEDS AND WALKING LEGS.	18
3.1 Introduction.	18
3.2 General anatomy of the limbs.	19
3.21 Articulations.	
3.22 Muscles.	
3.23 Nerve.	
3.3 Detailed anatomy of the effector axon innervations of the seven intrinsic limb muscles.	22
3.4 Functions of the effector axons innervating the opener, closer, stretcher and bender muscles.	26
3.41 Procedure.	
3.42 Excitation.	
3.43 Inhibition.	
3.44 Recording of excitation and inhibition.	

3.5	Anatomical and functional abnormalities.	40
3.6	Conclusion.	41
4.0	METHODS IN EXPERIMENTS ON REFLEX CLAW OPENING.	45
4.1	Mounting the animal for experimentation.	45
4.2	Synographic recording of opening of the cheliped dactyli.	47
4.3	Sensory stimulation.	47
4.4	Exposing and isolating the effector axons of the cheliped.	52
4.5	Disappearance of the claw opening reflex.	55
4.6	Experimental procedure after separation of the effector axons.	61
5.0	PRELIMINARY REPEITION OF HOFFMANN'S EXPERIMENTS USING MECHANICAL SENSORY STIMULATION.	65
5.1	Introduction.	65
5.2	Adaptation to long-duration mechanical sensory stimuli with all effector axons intact.	68
5.3	Adaptation to repeated mechanical sensory stimuli with all effector axons intact.	70
5.4	Adaptation with opener specific inhibitor out.	72
5.5	Adaptation with the common inhibitor out.	75
5.6	Possible causes of the reflex adaptation.	74
	5.61 Inhibitor adaptation.	
	5.62 Motor fatigue.	
	5.63 Sensory adaptation.	
	5.64 Central adaptation.	
	5.65 Conclusion.	
5.7	Adaptation to light mechanical sensory stimuli.	87
5.8	Adaptation to mechanical sensory stimuli of other forms.	94
5.9	Reflex inhibition of claw opening.	97
	5.91 The experiments of Hoffmann on <u>Atacus</u> .	
	5.92 Experiments with the opener motor axon transected.	
	5.93 Other experiments with opener axons intact.	
	5.94 Conclusion.	
5.10	Conclusion.	103

6.0	CEREBRAL, DIRECT AND REFLEX EFFECTS ON CLAW OPENING OF ELECTRICAL STIMULATION.	109
6.1	Introduction.	109
6.2	Localised rostral electrical stimulation.	110
6.3	General rostral electrical stimulation.	112
6.4	Localised electrical abdominal stimulation.	120
6.5	Conclusion.	127
7.0	CEREBRAL GANGLION ELIMINATION.	135
7.1	Introduction.	135
7.2	Effects of cerebral ganglion elimination on the claw opening reflex.	136
7.3	Effects of cerebral ganglion elimination on locomotor activity.	138
7.4	Other effects of cerebral ganglion elimination.	140
7.5	Conclusion.	141
8.0	DISCUSSION.	143
8.1	The nature of adaptation of reflex claw opening.	143
8.2	A possible basis for the difference between <u>Petamon</u> and <u>Astacus</u> .	146
8.3	Behavioural significance of the difference between <u>Petamon</u> and <u>Astacus</u> .	148
8.4	Mechanism of reflex responses and their adaptation in Decapod Crustacea.	149
8.5	Functional significance of peripheral inhibition.	151
8.6	General Conclusion.	153
9.0	SUMMARY.	154
10.0	REFERENCES.	159

1.0 INTRODUCTION.

Numerous investigations of the myoneural system of Decapod Crustacea from as early as 1887 (Biedermann), have contrasted this system with that of the Vertebrata. Recently (Ewer 1951) these two systems have been classified as oligoaxonic and polyaxonic respectively. Related to this anatomical difference is the difference in the mechanisms for effecting inhibition of muscle tone. Whereas this is effected entirely centrally in the Vertebrata, in the Decapod Crustacea it is peripherally effected, namely by the "inhibitory" axons which, in addition to the usual excitatory motor axons, innervate the muscles of the limbs, (Wiersma 1941 et al). Contraction of a limb muscle in response to direct stimulation of an excitatory motor axon innervating that muscle may be partly or wholly suppressed by simultaneous stimulation, at a suitable frequency, of the inhibitory axon innervating that muscle.

Such inhibitory axons are present in all four tribes of the Reptantia, and in the Natantia (Wiersma and Ripley 1952). Similar inhibitory axons have not been found in any groups of animals outside the Crustacea. However, non-excitatory axons have also been found in various insects innervating leg muscles, although an inhibitory function has not been attributed to these axons (Hoyle 1953 : Locusta sp., et al) What then is the biological function of the inhibitory axons in the intact Crustacean? How are they used?

Wiersma and Ripley (1952) consider that the "common inhibitors" of the Decapod Crustacea, single axons which innervate most or all of the intrinsic muscles of a limb, do not play a part in the normal locomotory movements of the animal, but that the individual inhibitors, which inner-

vate one or two muscles of the limb only, almost certainly do. They suggest, with no experimental evidence, that the common inhibitors function only in moulting, "to block reflex contractions resulting from the sensory bombardment of the central nervous system". The individual inhibitors they consider to have evolved independently in the four Decapod Crustacea tribes, as various means to the solution of the same problem, namely the functional fusion, in the form of a common excitor motor axon of the opener and stretcher muscles.

The only recorded attempt at an experimental solution to the above problem in the Decapod Crustacea is that of Hoffmann (1914). Using the common European fresh-water crayfish, Astacus fluviatilis Linn., he conducted experiments on a reflex response which he found to be evoked by pinching the tail, namely opening of the dactylus of the cheliped. In the intact animal Hoffmann found that the tension developed by the opener muscle in response to long duration or short repeated sensory stimuli to the tail gradually decreased. If however, the inhibitory axon innervating the opener muscle was transected, no decrease in this tension with long duration or repeated stimuli was observed. Furthermore, if instead of transecting the inhibitory axon the excitatory motor axon to the opener muscle was transected, and then stimulated peripherally, the contraction occurring in response to this peripheral motor stimulus was inhibited by a sensory stimulus to the tail of the animal. Hoffmann concluded that the inhibitory axon to the opener muscle of the Cheliped was the means whereby the reflex opening response became adapted to the sensory stimulus to the tail.

Clearly it is of importance, both from a functional and from a phylogenetic point of view, to know whether this result is in fact valid for the crayfish, and for other Decapod Crustacea, and how far it is applicable to the Crustacea in general and even perhaps to other Arthropodan groups.

There are no species of fresh-water crayfish occurring in South Africa. However, Potamon perlatum (M.Mw.) is the common species of fresh-water crab occurring around Grahamstown, where it is quite abundant. Furthermore P.perlatum responds to various forms of sensory stimulus, such as pinching or stroking the abdomen, by reflex opening of the claws, as does Astacus fluviatilis. This thesis is an attempt to repeat the experiments of Hoffmann, using P.perlatum. As nobody had worked out the innervation patterns of the limbs of any species of Potamon, it was necessary to do this before continuing with the main problem as outlined above.

## 2.0 MATERIAL AND APPARATUS.

### 2.1 ANIMALS.

The local species of fresh-water crab, Petamon perlatus, was used throughout the work. These crabs occur in the dams and shallow slow-flowing streams in and around Grahamstown. They live in the banks of the dams and streams, in burrows whose openings lie just at or above the water level.

#### 2.11 Collection of animals.

Most of the crabs used were collected from one fairly large dam. Collections were mostly made at night, when the animals were more active. The animals caught ranged in size from 5 to 10cms. carapace width, measured across the widest portion of the carapace. The majority (ca. 75%) were within the limits 6 to 9 cms., of which ca. 60% were females and ca. 40% were males. Females of 7.5cms. carapace width and greater were all mature, and of these ca. 5% were in berry, and were collected during the months August to October.

#### 2.12 Keeping the animals in the laboratory.

In the laboratory the animals were kept either in small glass-sided aquarium tanks or in specially made galvanised iron trays. These trays consisted of an outer tray 100 x 60 x 15cms., and an inner tray just fitting into the outer one. The inner tray had a perforated

galvanised iron bottom, galvanised iron partitions dividing it up into twenty compartments 20 x 15 x 15cms. and also a hinged lid of 1.3cms. wire mesh covering the whole inside tray. These trays were made in order to keep the animals separate to prevent fighting and cannibalism. Some of the glass aquaria were half filled with soil to a depth of 15 to 25cms. The aquaria and trays were filled with tap water to a depth of 4 to 8 cms., which was renewed twice or once a week.

The mortality rate per month over the year was about 10% in the galvanised iron trays, compared to about 8% in the aquaria containing water only and about 4% in the aquaria containing soil banks. These percentages exclude mortality due to cannibalism, which however was small when the glass aquaria were not overcrowded. During the winter months the mortality was slightly higher than during the summer months, but was kept down by leaving heaters on day and night in the laboratory, thus keeping the temperature higher and more constant.

The animals were fed, usually once a week, on about 5 gms. of raw beef.

### 2.2 PHYSIOLOGICAL SALINE SOLUTION FOR EXPERIMENTAL WORK.

For the experiments envisaged it was clearly desirable to have a physiological solution similar in ionic composition to the blood of the animals. No analyses of the ionic composition of the blood of Potamon spp. have been recorded, and time did not permit of such an analysis of the blood of Potamon perlatius in this study. However two determinations of the total ionic concentration of the blood of

POTAMON spp. have been made. Duval's (1925) determination of the freezing point depression of the blood of Telphusa (Potamon) sp. as  $1.2^{\circ}\text{C}$  corresponds to a value for the total ionic concentration of the blood of 350 millimoles per litre. Schlieper and Herrmann (1930) found the ionic concentration of the blood of Potamon fluviatile to be 340 millimoles per litre. These values are high compared to the value obtained (by van Harreveld (1936) ) for the fresh-water crayfishes Astacus trowbridgii and Gambarus clarkii, namely 243 and 222 millimoles per litre respectively.

The following physiological solutions and various modifications of these were tried during the course of experimental work, with varying degrees of success. They were all made up to a total ionic concentration of 350 millimoles per litre, to correspond to Duval's value for Potamon sp.; moreover the solutions were found to be most successful when made up to this total ionic concentration. 5 grams per litre of glucose was added to all the solutions. The solutions are here given in the order of their efficacy, as measured in terms of the longevity of the preparation in the solution, other factors being more or less the same.

1. Van Harreveld's (1936) physiological solution for Gambarus clarkii.
2. A modification of Schiff and Ewer's (1952) solution for Potamon sidneyi in which the  $\text{Na}_2\text{HPO}_4$  was replaced by 1.5 millimoles per litre of  $\text{NaHCO}_3$ .
3. Schiff and Ewer's solution unmodified.
4. Schlatter's (1941) solution for Astacus sp., quoted in Pantin (1948).

## 5. Prosser's (1935) solution.

Muscles and their axons, in limbs dissected as described later, if handled delicately, remained responsive to direct stimulation of the axons for periods of 5 to 8 hours after isolation of the axons in solution no. 1, and for progressively shorter periods in solution nos. 2 - 4. In solution no. 5 such preparations remained responsive for less than 3 hours. In later work only solution no. 1 was used. This was made up from solutions of the component salts in distilled water, with the addition of powdered glucose, as shown in table 1.

Table 1

<u>Salt</u>	<u>Solution of salt</u> (m. moles per litre)	<u>Amount of solution used</u>	
		m. Moles	m. litres
NaCl	540	324.0	600
KCl	540	8.1	15
CaCl <sub>2</sub>	360	10.8	30
MgCl <sub>2</sub>	360	3.6	10
NaHCO <sub>3</sub>	100	4.0	40

Distilled water to make up to

1000ml.

Total ionic concentration

350.5 m.moles.

Glucose added 5 grams.

2.3 DISSECTING APPARATUS.2.31 Microscope

A Zeiss stereoscopic binocular dissecting microscope was used

throughout for dissection in making anatomical and experimental preparations. In the experiments in which the whole animal was used, the lens housing and focussing portion of the microscope was removed from the vertical base stand and clamped to it by two retort clamp X-blocks and two 15cm. long brass rods of the same diameter as the vertical base rod. The vertical brass rod was bent in the middle of its length through an angle of 20 degrees. In this way sufficient clearance was obtained beneath the objective lens for the preparation and in front of it for the recording lever threads. It also permitted easy alignment of the objective lens with the portion of the animal under observation. The base of the microscope was clamped to the edge of the bench.

#### 2.32 Lamp.

A Watson variable intensity dissecting lamp with detachable transformer-base was used. The lamp housing was detached from the base and clamped on a retort stand at the back of the bench. It could then easily be swung round and moved vertically to focus on any portion of the preparation.

#### 2.33 Needles.

For dissecting the nerves and separating the axons it was necessary to have very fine dissecting needles. These were each made by fixing with "Samsonite" glue a fine entomological pin into the finely drawn out end of a length of glass tubing serving as a handle. The pin was bent at a convenient angle to the glass handle for dissecting.

The ends of some of the pins were bent into fine U-shaped hooks for holding and lifting axons. For splitting motor axon bundles into their individual axons a mounted stainless-steel surgical needle, smoothly ground down on two sides to form a flattish and very thin sharp two-edged blade, as used by Ripley (personal communication), was found to be more suitable than the entomological pin needle.

#### 2.4 STIMULATING APPARATUS.

In the experiments on reflex excitation and inhibition it was necessary to have some means of applying a controlled and constant repeated sensory stimulus. Two main types of sensory stimulus were used: mechanical tactile stimulation, and electric current stimulation. Various forms of each of these two types of sensory stimulation were experimented with. The most useful and effective mechanical stimulus was applied in various forms with the "titillator", presently to be described. For giving an electric sensory stimulus an electronic square-wave oscillator stimulator was used. A second square-wave oscillator was used for peripheral stimulation of the nerve axons in the limbs; this stimulator was adjusted for a smaller and lower-voltage output range than the first oscillator.

##### 2.41 Mechanical hammer stimulator ("titillator").

This apparatus was constructed from a BTL Du-Bois Raymond <sup>induction</sup> coil with variable frequency of interruption, constructed to work off one

or two 2 volt accumulators. The sliding secondary coil of this instrument was discarded. The primary coil was used as a magnet to attract the hammer weight of the current-interrupter portion of a second BTL Du-Bois Reymond induction coil. This hammer was secured into position next to the unattached end of the primary coil by screws screwed into the baseboard of the first instrument.

The frequency of the hanner beat could be altered by adjusting the frequency adjusting screw of the first interruptor. The amplitude of the beat, and therefore the intensity of the stimulus, could be altered by adjusting the frequency adjusting screw of the second interrupter. The frequency of beat was of course equal to the frequency of interruption of the current in the induction coil.

This instrument was then mounted on the lens tube with rack and pinion of a microscope, the lens tube being parrallel with the induction coil. This permitted movement of the whole stimulator apparatus in the direction of beat of the hammer head, so that the hammer head could be moved towards or away from the animal. The plane of beat of the whole hammer was parallel to the baseboard of the induction coil, which in its normal position was horizontal. This plane could be tilted to almost any angle about an axis parallel to the hammer rod. This was made possible by having the lens tube rack and pinion column mounted directly onto the microscope base and pivoting in the normal way in a vertical plane about the pivot between these two sections of the microscope. The plane of beat of the hammer could also be rotated about an axis through the centre of the rack and pinion column parallel to

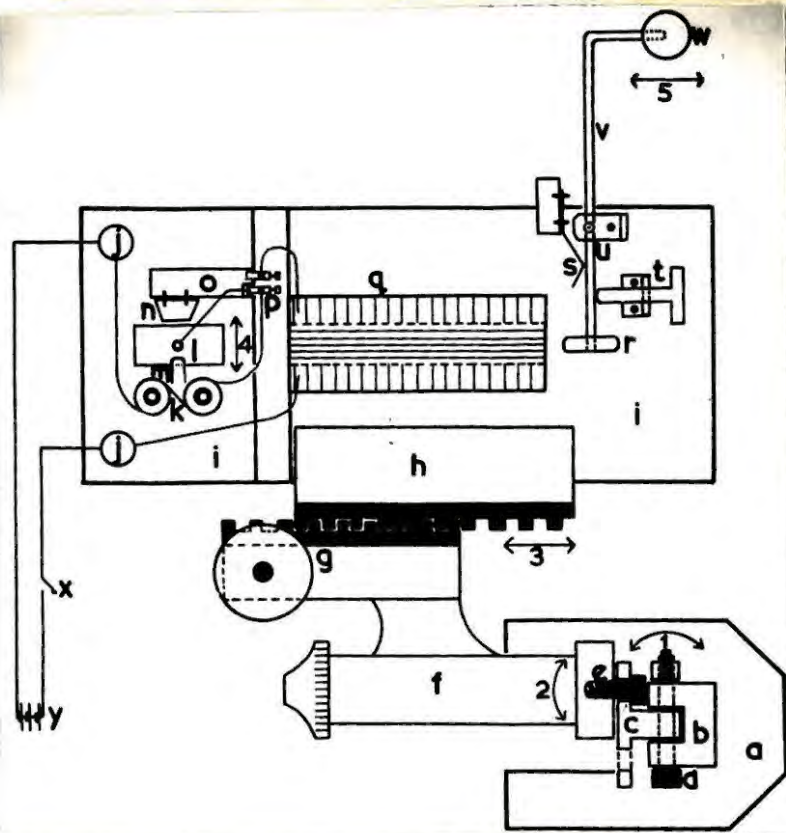

Fig. 1. Diagram of the mechanical hammer stimulator ("titillator"). Plan view with the hammer in position for horizontal beat.

- a brass base of microscope
- b pivot bracket on vertical base stand
- c T-piece connecting pivot bracket and rack-and-pinion column
- d pivot bolt connecting, and allowing rotation between, b and c
- e single T-piece belt connecting, and allowing rotation between, c and f
- f rack-and-pinion column
- g rack-and-pinion screw and teeth
- h lens tube of microscope
- i base-board of Du-Bois Raymond induction coil
- j terminals of ditto
- k coils attracting current-breaker hammer
- l current-breaker hammer weight
- m frequency-adjusting screw
- n flat metal spring against which hammer rod beats
- o brass block to which spring (n) and terminals (p) are fixed
- p two terminals, one of which is insulated from brass block (o)
- q primary of induction coil
- r weight of stimulator hammer
- s flat metal spring of stimulator hammer
- t adjusting screw for changing amplitude of hammer beat
- u fulcrum of hammer
- v rod of stimulator hammer
- w plasticine ball on end of stimulator hammer
- x circuit-maker key coupled with signal-marker key
- 1-3 the three motions for adjusting the position and direction of stimulator hammer beat
- 4,5 directions of beat of current-breaker and stimulator hammers
- y Three two-volt accumulators giving the current for stimulator

the direction of beat of the hammer head. This was made possible by having the rack and pinion column attached to the microscope base by only one bolt about which rotation could occur. The rack and pinion column could then be fixed in almost any position relative to the microscope base on which it moved by means of two retort clamps and blocks with a short metal rod clamped in both blocks between two clamps.

The whole apparatus is shown diagrammatically in fig.1.

#### 2.42 Electronic square-wave oscillator stimulator.

The circuit originally used in building a square-wave oscillator and power pack was that of Ripley and Kirk (personal communication). This is a somewhat modified and simplified version of Bernstein's (1950) circuit. The power pack and oscillator are incorporated into a single unit. This circuit was found to be inadequate for the work on Crustacean axons in the following respects:

1. The amount of A.C. smoothing was insufficient.
2. The switch system allowed pulse leakage to the chassis.
3. The amplitude control was too insensitive, i.e. the curve of output voltage x scale setting was too steep.
4. The pulse form as seen on an oscilloscope was not as square as was desirable.

These and other minor faults were corrected by adding and altering components accordingly. The circuit thus finally arrived at is shown in fig.2. This was found to be adequate for all further requirements.

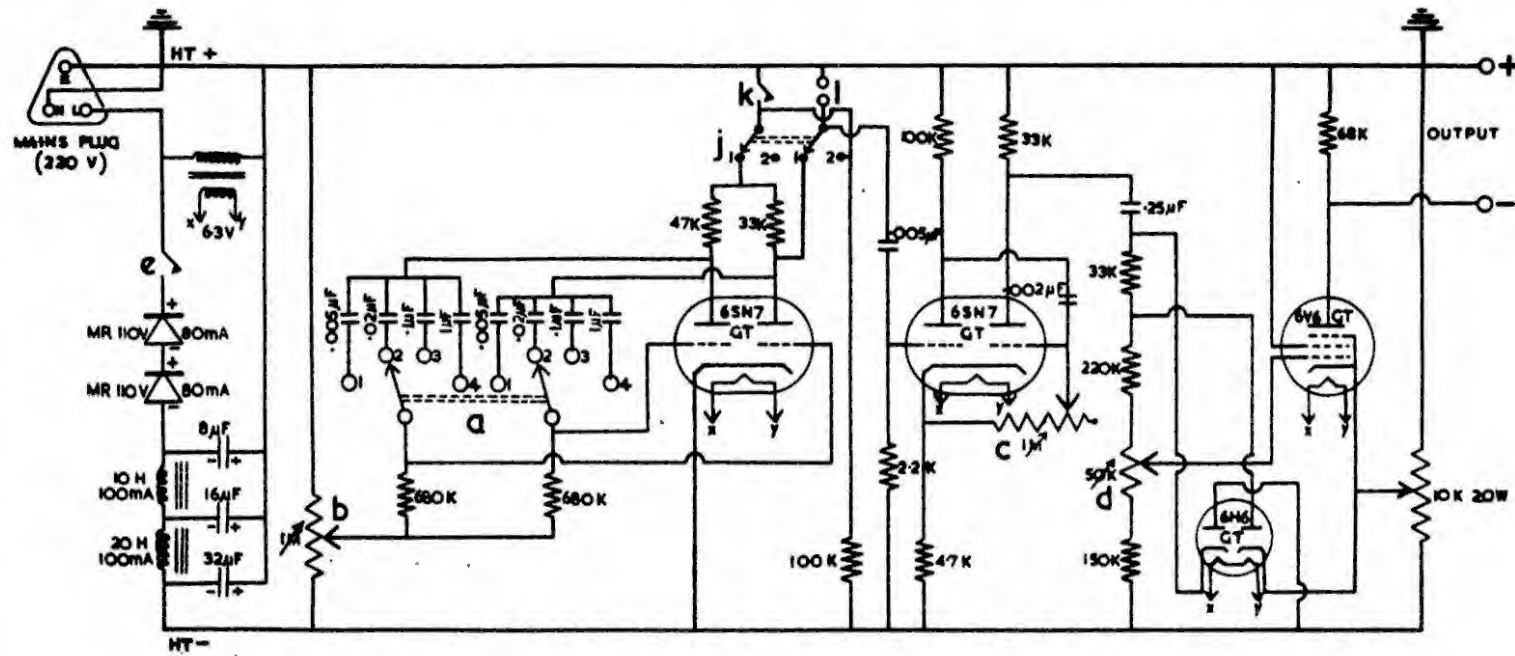

Fig. 2.

Circuit diagram of the electronic square-wave stimulator.

- a frequency range selector
- b fine frequency control
- c pulse duration control
- d output amplitude control
- e toggle switch for switching off HT supply
- j position 1 : repetitive pulse ; position 2 : single pulse
- h stimulus make and break switch
- i terminals for external stimulus switch

In the initial anatomical experiments on the individual limbs a second square-wave oscillator, built on the Bernstein circuit, was used to find inhibitory axons. However, this instrument produced an output wave-form too different from that of the first oscillator to enable it to be used successfully together with the first instrument, so it was abandoned. Instead two electrode pairs were led off in parallel from the output of the first oscillator. The disadvantage of this system, of course, is that the pulse frequency of the stimuli applied simultaneously to the motor and inhibitory axons could not be varied independently in the two axons. This also applied to pulse amplitude and duration.

Each pair of electrodes had its own mercury-cup switch to break the cathode line. The mercury-cup switch was found to be very convenient for this purpose, and to give very clean make and break shocks, especially when a 0.005  $\mu\text{F}$  condenser was connected across the two negative terminals of the switch. Complete elimination of all incidental discharge in the electrodes while switched off was achieved by connecting the negative and the positive (earth) leads together to earth by means of this switch, which was a double pole two position switch. The relevant signal marker circuit was completed through the two terminals of this switch in parallel to the two electrode lead terminals.

#### 3.43 Electrodes.

Four different electrode combinations were used. One of these was used only for applying a sensory stimulus, the other three were used for peripheral stimulation.

1. The pair used for sensory stimulation consisted simply of two pieces of fairly stout platinum wire soldered on to the ends of short lengths of thin flexible plastic-covered copper wire mounted parallel to each other in a little wooden block (fig.3a). This wooden block was mounted on one end of a brass rod whose other end could be held firmly by a thumbscrew in a small brass fitting which screwed into the thread for the objective lens of a microscope. This gave the vertical motion of the rack and pinion of the microscope, and also a very smooth rotation about the axis of the microscope lens tube. One of the two wires formed the cathode and the other the anode (earth). Sometimes a separate anode was used, similar to the anode just described; this was mounted on the end of a brass rod which was clamped to the retort stand to which the preparation was clamped, and connected to the earth lead which was soldered to this retort stand.

2. The Cathode used in the preliminary anatomical experiments on single limbs was a small U-shaped platinum wire hook shaped conveniently for lifting single axons and just large enough to lift the whole limb nerve. This was soldered to the end of a short length of insulated wire, which was fixed onto a small lever mounted in a universal bearing obtained from a crystal detector set (fig.3b). The universal bearing holder was in turn mounted on the end of a brass rod which was clamped onto a small stand. The anode used in these experiments was similar to that described in 1 above, and was mounted on a brass rod clamped to a retort stand.

3. The second cathode used in the preliminary anatomical experiments was a hook electrode similar to that described in 2 above.

Fig. 3.

1. Diagram of electrodes used for sensory stimulation.

- a Anode ( earth) lead ; metal shielding
- b wooden block holding electrode leads
- c cathode lead
- d brass rod clamped to microscope in objective lens position
- e platinum wire electrodes

2 Diagram of universal bearing holder, with electrode for axon stimulation.

- f cathode lead
- g metal shielding round cathode lead
- h platinum wire hook electrode
- i metal rod bearing electrode lead
- j handle for i
- k universal bearing
- l screw for adjusting pressure on ball bearing
- e Falser X-block
- p clamp screw
- r brass rod clamped to microscope in objective lens position

Fig. 4.

Diagram of micromanipulator electrode holder.

- a microscope lens tube
- b brass fitting screwing into a and holding a with thumbcrew
- c brass rod holding adjustments for sideways and back and forth (motions)
- d lead-screw adjustment giving sideways motion
- e moving portion of sideways adjustment
- f metal ring holder for condenser lens
- g Falser X-block
- h retort clamp
- ij lead-screw adjustment giving backwards and forwards motion
- lm moving portion of backwards and forwards adjustment
- k metal ring holder for condenser lens
- n brass rod holding electrode on its other end

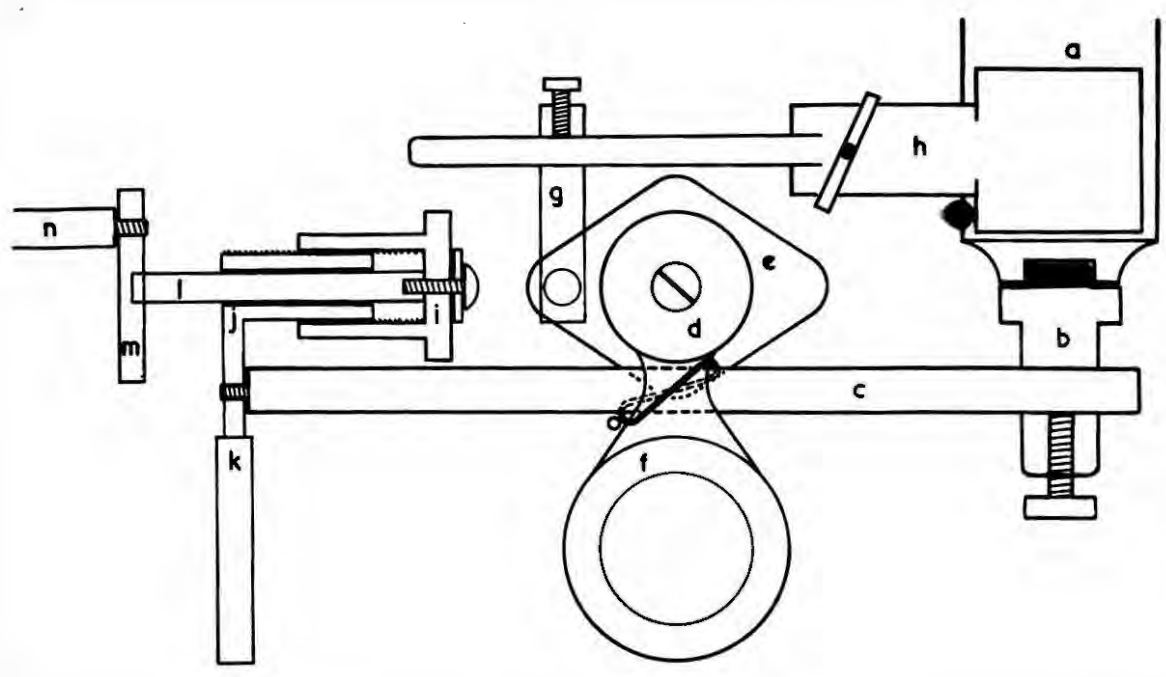
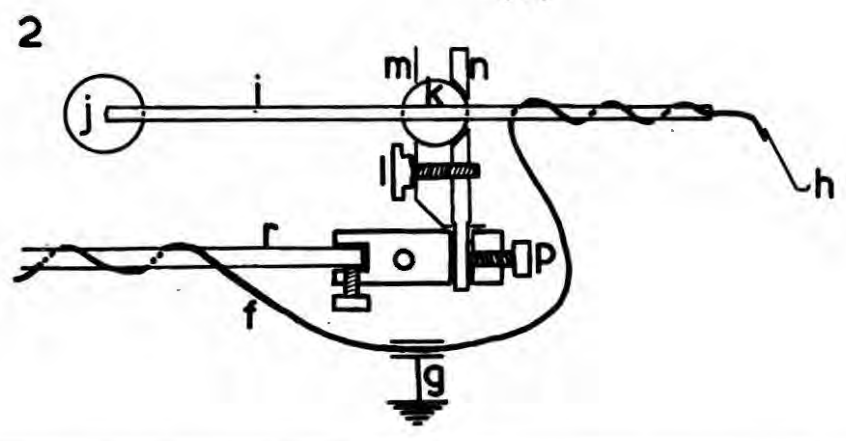
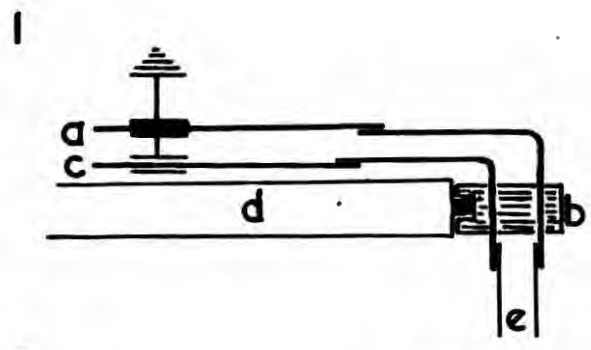

The lead for this electrode was mounted on a brass rod whose other end was clamped into a brass fitting screwing in the objective lens position of a microscope as in 1 above.

4. The cathode holder described in 2 above was used initially in the experiments on reflex excitation and inhibition, but proved too clumsy in manipulation. Using the same form of hook-shaped electrode, a rather crude but nevertheless efficient micromanipulator electrode holder was therefore developed. The vertical motion was given by the rack and pinion of a microscope, with brass rod fitted as in 1 above. On the free end of this brass rod was fixed the lead screw adjustment for focussing of the sub-stage condenser lens of the microscope, this giving a backwards and forwards motion to a second brass rod which carried the electrode and was attached to the movable portion of the lead-screw adjustment. A sideways motion was imparted to the electrode by a second identical lead-screw adjustment mounted at right angles to the first, clamped with a retort clamp to the microscope lens tube and pushing and pulling against the brass rod holding the first lead-screw adjustment. See fig. 4. As an anode the electrode mounted on the universal bearing as described in 2 above was used.

The two electrode leads were connected to separate mercury-cup switches, which in turn were connected in parallel to the oscillator output terminals, in such a way that in the "off" position of each switch the relevant electrode was connected to "earth", while in the "on" position the electrode was connected to the negative output terminal of the oscillator. That is, the electrode of the switch that is switched "on" becomes the cathode, the other remains the anode for that stimulus.

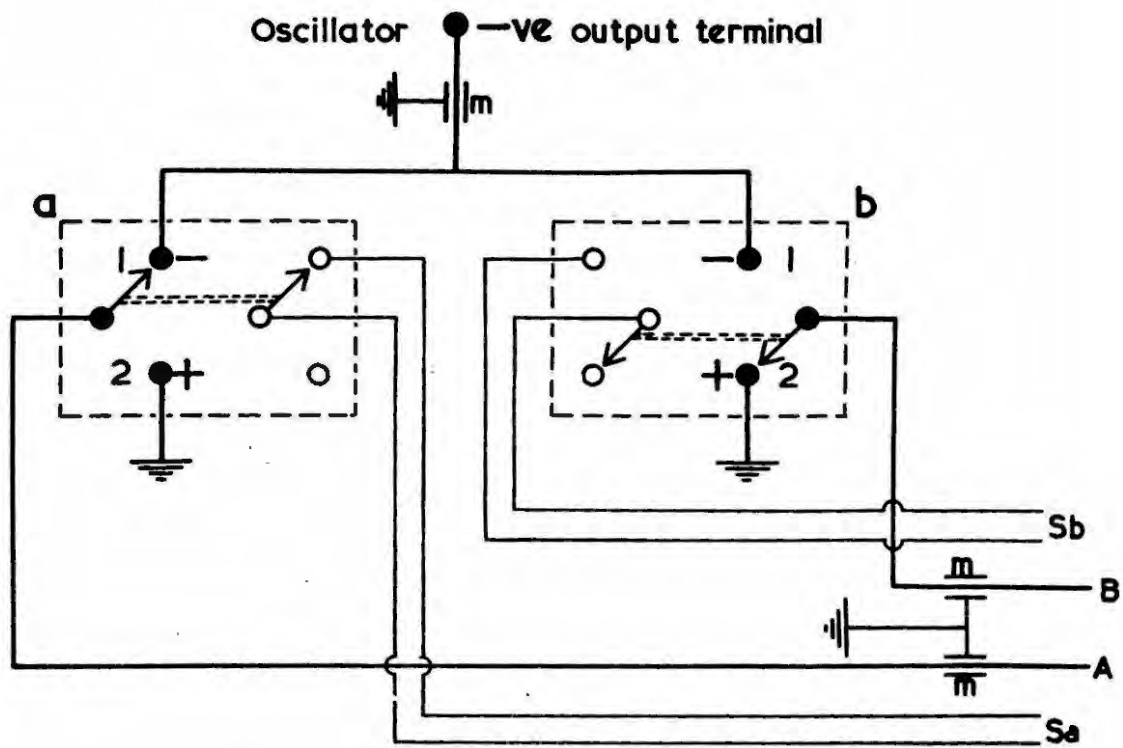

Fig. 5.

Circuit diagram of switch system used for dual cathodes or polarity reversal

- a switch in position for cathode
- b switch in position for anode
- A cathode lead
- B anode lead
- Sa cathode signal marker leads
- Sb anode signal marker leads
- m metal shielding, earthed

In this way the polarity of the two electrodes could be easily reversed. This switch set-up is similar to that employed for the two cathodes when these were used with a third electrode as anode in the preliminary anatomical experiments; it is shown diagrammatically in fig. 5.

Initially, ordinary thin plastic-covered electrical wire was used for electrode leads. However this was found to be picking up stray A.C. and transmitting it to the electrodes; this current, although minute, sometimes reached values of 0.05 to 0.07 volts, which was sufficient to excite single axons. This was eliminated by using screened radio wire leads for the electrodes, the screening sometimes being used as the anode (earth) lead. Any small current leakage from the oscillator that might occur while the output current was switched off was eliminated by wiring the switch so that in the "off" position the two electrode leads were connected together to "earth".

## 2.5 RECORDING APPARATUS.

### 2.51 Kymograph, signal markers, time marker.

A Palmer electric kymograph with smoked drum was used for all mechanical recording of muscle response. The rack and pinion motion of a microscope, fixed to the edge of the bench, was used to move the kymograph towards and away from the recording lever points. The stimulus duration was marked on the smoked paper with an electro-magnetic signal marker, this being coupled with the stimulus make and break switch by means of a double pole switch. The time intervals were marked on some of the traces with an electro-magnetic time-marker, giving inter-

-vals of 1 or 5 seconds.

### 2.52 Recording Levers.

For all recording of limb muscle contractions and their respective joint movements light auxotonic levers were used. These each consisted of a 10cm. long flat aluminium rod moving about a central pin fulcrum held in a U-shaped bracket. A light helical extension spring was attached to this rod vertically above it at a variable distance from the fulcrum on one side of the fulcrum. The cotton thread attached to the limb segment whose movements were being recorded was tied to the lever rod, also at a variable distance from the fulcrum, so as to pull against the spring. Sometimes this thread moved around a light Palmer pulley so as to be aligned with the direction of movement of the limb segment being recorded. On the free end of the lever rod a light drinking straw was slipped and thus firmly held in place. A short pointed piece of celluloid was glued onto the free end of the straw, and the pointed end of it melted in a small flame into a small globule, forming a smooth writing point of the desired thickness. See fig. 6.

Theoretically the extension of a helical spring per unit load, and therefore the displacement of the recording lever resulting from the extension of the spring, decreases slightly per unit increase in spring loading for anything more than very slight extensions of the spring. However, this did not apply for the springs used. The spring extensions and resulting lever displacements if anything increased with unit increases in the spring loading.

Fig. 6.

Diagram of recording lever used in mechanical recording of limb segment movements.

- a celluloid writing point with tip melted into a ball
- b drinking straw
- c flat aluminium rod
- d hole for end of spring
- e V-notch for cotton
- f lead weight
- g U-shaped brass bracket bearing fulcrum adjusting screws
- h brass rod clamped to rest on stand
- i ball block bearing spring-holding screw
- k lever spring
- l cotton thread
- m fulcrum recording lever

Fig. 7.

Kymographic recording of lever pointer displacements for given loads.

- a Displacements for a light spring, typical of those used in the axon innervation experiments.
- b Displacements for a heavier spring, typical of those used in the reflex claw opening experiments

Magnification : 1x

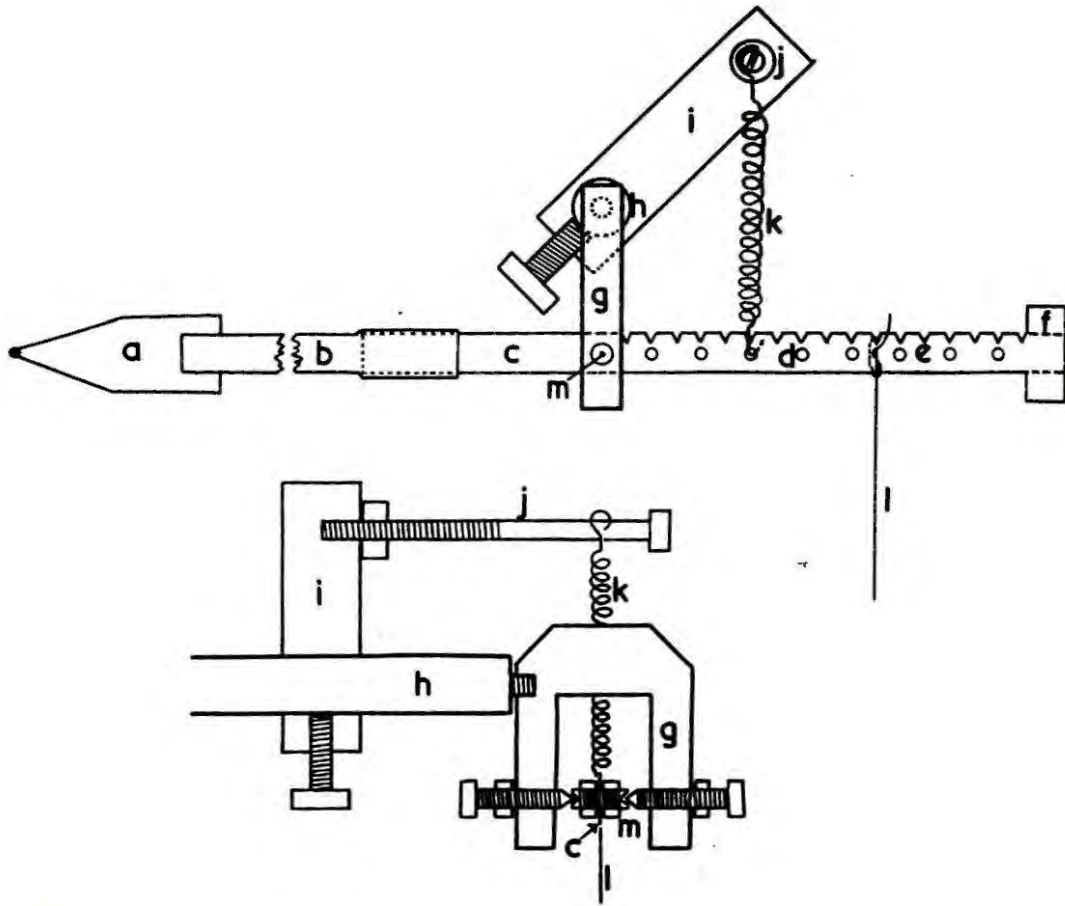

**a**

Gms.

0	_____
1	_____
2	_____
3	_____
4	_____
5	_____

**b**

Gms.

100	_____
90	_____
80	_____
70	_____
60	_____
50	_____
40	_____
30	_____
20	_____
10	_____
0	_____

In the preliminary experiments on axonal innervation very light extension springs were used for the recording levers, whereas in the subsequent experiments on reflex claw opening, heavier springs were used. In the latter experiments, in which the movements of two claws were being recorded simultaneously, the two levers were adjusted to give proportionately equal displacements for the same loads.

In the innervation experiments the recording thread was attached to the lever rod on the same side of the fulcrum as the writing point, so that the limb segment movements were recorded as downward displacements of the writing point. On the other hand, <sup>in the</sup> reflex claw opening experiments the thread was attached to the lever on the opposite side of the fulcrum from the writing point, so that limb segment movements were recorded as upward displacements of the writing point. Fig. 7 shows typical displacements for given loads on the threads of the recording levers used in both the innervation and the reflex claw opening experiments.

### 3.0 ANATOMY OF THE CHELIPEDS AND WALKING LEGS.

#### 3.1 INTRODUCTION.

Before it was possible to experiment with reflex movements in the chelipeds, it was necessary to know the anatomy of the limb, and in particular the axonal innervation of its distal muscles. Wiersma and his co-workers have established the innervation patterns of the chelipeds and walking legs of a number of species of Brachyura, as well as of numerous representatives of other tribes of the Decapod and some Stomatopod Crustacea (Wiersma and Ripley 1952, et al). This work was done by the combined use of anatomical, histological and physiological techniques. In no species has any significant difference been found between the innervation pattern for the chelipeds and that for the walking legs. Nobody has worked out the innervation patterns of the limbs of any Potamon species.

In the present investigation both chelipeds and walking legs have been used. Physiological investigations were more easily carried out on the walking legs. The use of the walking legs also avoided having to use too many crabs, which would have been necessary if only chelipeds were used. Here again, no significant difference in innervation patterns was found between chelipeds and walking legs. Since the later sections on reflex claw opening primarily involve the chelipeds, the present section on axonal innervation will therefore refer to the chelipeds unless indicated otherwise. Other differences between the two types of limb will be referred to.

3.2 GENERAL ANATOMY OF THE LIMBS.3.21 Articulations.

At each of the four moveable joints in a limb the articulation is such as to allow movement of the more distal segment in one plane only. The only rotatory movement possible is at the base of the limb, between the sternal plate and the coxopodite. In order to designate the movements of the different segments of the limbs, and the muscles producing these actions, the terminology of Wiersma will be used throughout, both in the chelipeds, for which it was developed, and in the walking legs.

Table 2 summarises the movements of the segments of the limbs and gives the muscles responsible for these movements and the locality of the muscles. The movement produced by each muscle in the walking legs is implicit in the generalised name of the muscle. The first seven muscles named in this table will be referred to as the intrinsic limb muscles.

TABLE 2.

Locality of muscle	Generalised name of muscle	Name for cheliped	Movement produced in cheliped
Propus	Adductor dactylopeditis Abductor dactylopeditis	Closer Opener	Closing claw Opening claw
Carpus	Productor propoditis Reductor propoditis	Bender Stretcher	Up and forward Down and back
Merus	Adductor carpopoditis Abductor carpopoditis Accessory adductor carpo.	Flexor Extensor Acc. flexor	Forward Backward Forward
Ischio-basipodite	Reductor meropoditis	---	Backward (very slight)

3.22 Muscles.

It is seen that each of the three distal segments of the limbs is moved by two antagonistic muscles situated in the adjacent proximal segment. Each muscle has its own tendon or ligament. Each tendon consists of a thin, soft, but strong, cartilaginous-like plate, of an elongated ovoid shape. The tendon is attached at its distal end to the proximal edge of a small, hard, flat, calcareous platelet lying in the joint between the two segments. The distal edge of this platelet, in turn, articulates with the more distal of the two segments, which segment is thus moved by the muscle in the more proximal of the two segments. The tendon usually lies in the same plane as the tendon platelet, but it may lie in a plane at right angles to this, as in the case of the opener and closer muscle tendons of both the chelipeds and the walking legs.

The muscle fibres of each muscle run diagonally from their origin on the inside integumental surface of their segment to their insertion on the flat surface of the tendon. Part of the muscle inserts on one side of the tendon and part on the other side.

This generalised description applies to all the muscles in the propus, carpus and merus except the accessory flexor muscle. This muscle is very small, and in some chelipeds, but not in the walking legs, appeared to be almost vestigial, although in some cases this may have been a result of regeneration. It lies near the nerve at its antero-ventral aspect, and runs the length of the merus alongside the flexor.

It comprises a small group of longitudinal muscle fibres at each end of a long thin rod-shaped tendon, each group of fibres being about a quarter of the total length of the "muscle". It originates proximally in the merus and inserts on the anterior corner of the flexor platelet. The form and particularly the smallness of this muscle makes it improbable that a contraction of its fibres would have much effect in flexing the carpus.

### 3.23 Nerve.

The single nerve of the limb, carrying all the motor and sensory fibres to and from the limb segments, lies between the two antagonistic muscles in each segment, branching out to the muscles and integument from this situation. The motor axons to the muscles generally branch off from the main nerve trunk near the articulation just proximal to the muscle being supplied, and ramify in the interface between the two antagonistic muscles over the surface of the muscle before branching to the deeper muscle fibres. Thus the motor fibres to the opener muscle of the limb branch out into this muscle from the interface between the opener and closer muscle. However, the motor axons to the closer muscle, together with the sensory fibres which in the cheliped run into the immovable ramus of the claw, leave the main nerve tract which runs between the opener and closer muscles, and run more ventrally in the propus between two sections of the closer muscle. The motor fibres to all the other intrinsic limb muscles branch from the main nerve trunk in the interface between the two muscles of the segment.

### 3.3 DETAILED ANATOMY OF THE EFFECTOR AXON INNERVATIONS OF THE SEVEN INTRINSIC LIMB MUSCLES.

NOTE: For the purposes of this thesis the term "effector axons" refers to any axons innervating one or more muscles, and therefore includes both motor and inhibitory axons.

The effector axon innervations of the seven most distal intrinsic muscles of the chelipeds and walking legs, namely the opener, closer, stretcher, bender, extensor, flexor and accessory flexor, have been studied. Physiological investigations of the functions of the effector axons have, however, only been made on those innervating the opener, closer, stretcher, and bender. Two methods of tracing the effector axon innervations of these four muscles were used. Initially, before physiological investigations were commenced, the axons were traced, from their points of branching off the main trunk, both into the muscles and back along the nerve trunk. The second method, used during the physiological investigations, was to trace an axon, after its function had been found by direct stimulation, from the point of stimulus in the merus to the muscle innervated by it, noting its relationship with other effector axons. For the three muscles in the merus only the first of these two methods was used.

Two approaches were used to get at the axons where they left the main nerve trunk and entered the muscles. One was to cut open the integument in the region of the surface of attachment of one of the two muscles of a segment and very carefully remove this muscle, leaving the nerve supply to the other muscle intact on its exposed face. The other was to cut open the integument in the region of the interface of the two

muscles, and then carefully to dissect away or just move aside parts of the two muscles to expose the nerve supply to both of the muscles.

The dissection was done under water or physiological saline solution. Methylene blue was used to facilitate tracing the motor axons. The simplest and most satisfactory way of applying the methylene blue was with a small micropipette fitted with a rubber suction bulb on one end. A filtered saturated solution in water of methylene blue was gently pipetted on to the portion of the nerve fibres being dissected. This was allowed to remain for a few seconds and then washed away with water from another micropipette. The heat from the dissecting lamp, by raising the temperature of the solution, reduced the stain to its colourless leucobase within 5 to 15 minutes, so that the procedure had to be repeated quite frequently. With a little practice this method could produce quite a clean differentiation between nerve fibre and muscle fibre, although fine blood vessels were often difficult to distinguish from motor axons lying alongside them.

The whole nerve trunk in the limb is best seen in the merus when the three muscles in the merus have been removed, leaving the nerve free in the middle of the merus. The single main blood vessel of the limb lies alongside the nerve on its poster<sup>o</sup>-ventral aspect, usually closely attached to the nerve by thin connective tissue. It gives off numerous small branches to the flexor and extensor muscles and to the nerve. The blood vessel may be separated from the nerve by carefully cutting the small branches to the nerve and the connective tissue. The nerve itself is covered by a very thin sheath, which can be split open

with a sharp needle and removed from the nerve. The nerve is then seen to be composed of numerous bundles of varying diameters and numbers of fibres. The large majority are sensory fibre bundles.

The effector axons, as seen in the fresh unstained condition, could, with some experience, be distinguished from the sensory fibres and from the small sensory fibre bundles by their being more transparent than the usually almost opaque white sensory fibres and small bundles, and by their being larger in diameter than the sensory fibres. The effector axons were ~~not~~ in a single bundle, but were usually more or less aggregated together near that surface of the nerve which lies against the blood vessel. Normally they comprised three bundles of axons, A, B and C, bundle A having three axons (axons 1 - 3), bundle B also having three axons (axons 4-6), and bundle C having only two axons (axons 7 and 8). Sometimes small sensory bundles of similar diameter to the single motor axons were included in these motor axon bundles. The relative diameters of the different effector axons were normally approximately the same in different limbs. Bundle C had one large axon (axon 7) and one small axon (axon 8); two of the axons of bundle B (axons 5 and 6) were of about the same diameters as axons 7 and 8 respectively and the third axon (axon 4) was very much thinner; the three axons of bundle A were all about the same diameter, intermediate between the two axons of bundle C, though axon 1 was generally slightly thicker than axons 2 and 3.

When these effector axons were traced to their respective muscles, it was found that the two axons (7 and 8) of bundle C innervated the closer muscle, the three axons (4-6) of bundle B innervated

the bender muscle, and of bundle A axon 1 innervated the opener, axon 2 the strecher and axon 3 branched to innervate the strecher before going on to innervate the opener as well. Occasionally when great care was taken it was possible to trace a branch of the very thin axon 4 to each of these four muscles. Fig 8 (A and C) summarises, in diagrammatic form, these observations.

It was usually not difficult to trace these groups of axons, except the very thin one, as far as and just distal to the points at which they branched off from the main nerve trunk. Almost invariably the axons innervating a particular muscle left the main nerve trunk together as a compact group. Frequently they could be traced further distally, and be seen running together fairly deeply into the muscle, and branching together at irregular intervals. They were not however traced to their finer ramifications and endings on the muscle fibres.

Altogether approximately 25 chelipeds and 40 walking legs were used in determining the axon innervations of the four most distal muscles of the limbs. Of these, the axons were traced from the merus after isolation by stimulation in 17 chelipeds and in 22 walking legs; in the other limbs the axons were traced by dissection only. In only 5 chelipeds and 4 walking legs were all the axons of these four muscles traced to their respective muscles; in each of the other limbs one or more axons were traced.

In approximately 40 additional chelipeds and 10 additional walking legs, which were being used in the physiological innervation experiments, the position and distribution into bundles in the merus of all the motor axons of these four muscles was noted, without

Fig. 8.

- a, b Diagram showing the effector axon innervations of the six main distal muscles of the cheliped or walking leg. The relative thickness of the effector axons in a normal limb are approximately as shown. The dotted line in b represents an axon which was found in only three out of six limbs.
- c Diagram showing the relative positions of the effector axons in the merus, as found in a normal limb after dissecting out the flexor and extensor muscles. The relative thicknesses of the effector axons are approximately as shown, but are much smaller as compared with the other structures shown.

Fig. 9.

Drawing of a cheliped preparation as used in determining the function of the effector axons of the limb.

- a suture at which natural autotomy takes place : the limb was usually severed at this suture for the type of preparation shown
- b tendon plate, which articulates on the carpus, and on which articulates the flexor tendon
- c1 antero-dorsal cut edge of merus
- c2 postero-ventral cut edge of merus
- d anode
- e cathode
- f surface of the saline beneath the axon
- g cotton thread in place for recording closing

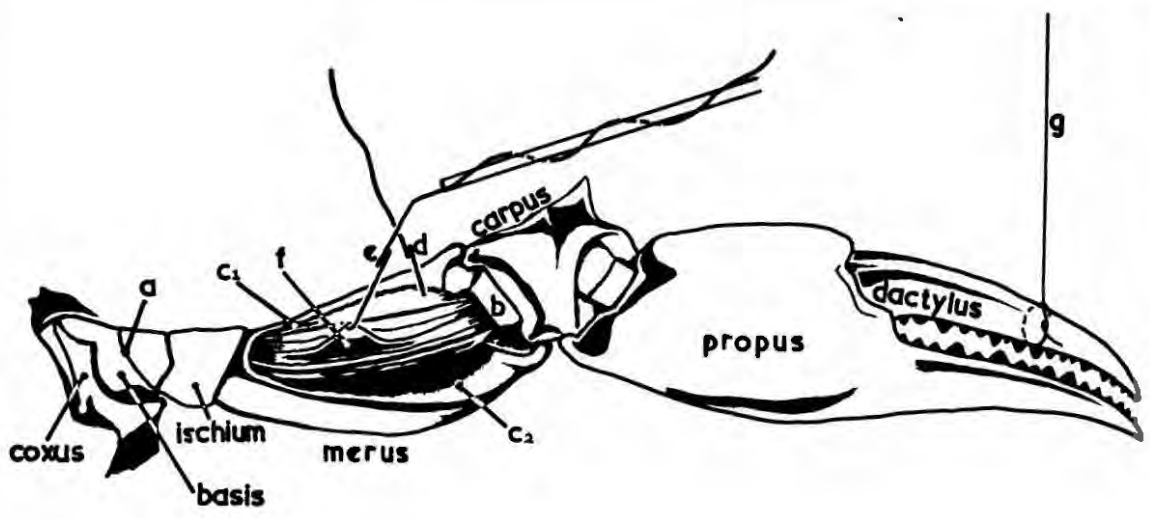
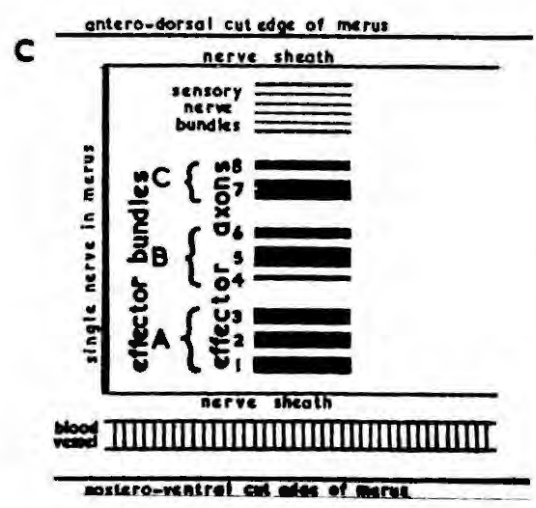
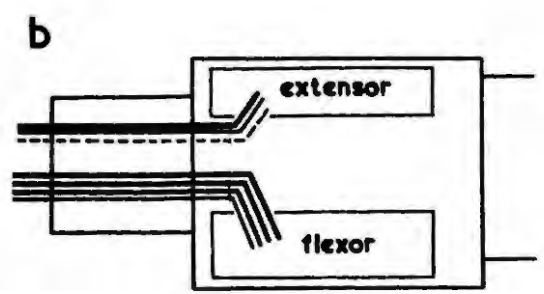
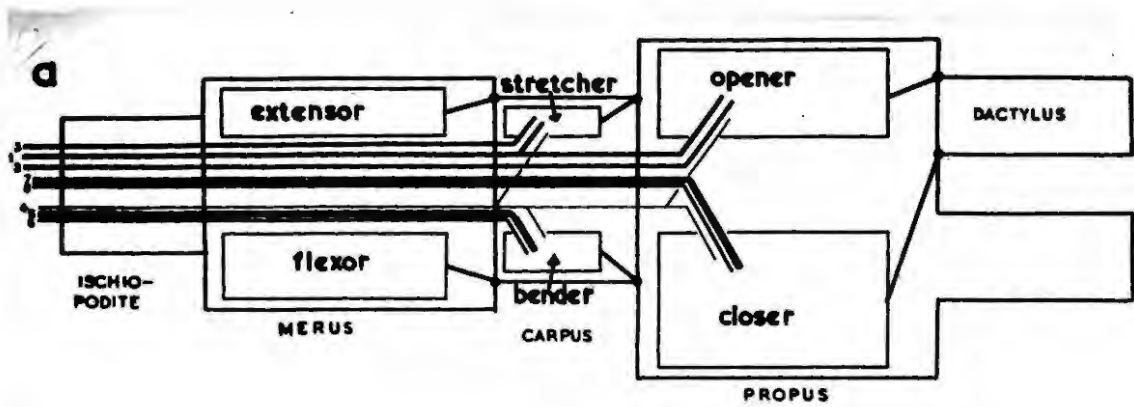

subsequently tracing them to their respective muscles. In a further 80 or so chelipeds, used in the reflex claw opening experiments, the arrangement of the three axons to the opener and stretcher muscles in the merus was noted.

Approximately 55% of all the chelipeds and 70% of all the walking legs investigated showed the above-described anatomical relations of the axons innervating the form distal limb muscles. Regenerated chelipeds could usually be distinguished at a glance by the presence of a slight scar in the basi-ischiopodite at the point of natural autotomy of the limb, and sometimes, in the case of a right cheliped, by its being smaller than the usually smaller left cheliped, and in the case of the cheliped having been regenerated relatively late in <sup>the</sup> life of the animal, by its abnormally small size.

In regenerated limbs the distribution of the effector axons in the nerve almost invariably differed to some extent from the normal condition described above. A difference occurring in at least 60% of regenerated limbs was the displacement of bundle A, of effector axons to the opener and stretcher muscles, so that it lay in close contact with the blood vessel alongside the nerve, either on the same side of the blood vessel as the rest of the nerve or less frequently on the opposite side of the blood vessel and completely separated from the rest of the nerve. Such displacement of bundle A occurred even in limbs which showed no other sign of being regenerated than a very slight scar at the point of autotomy. In about 10% of regenerated limbs all the effector axon bundles, although normal in themselves,

were displaced at random to various parts of the nerve, and were consequently very difficult to find. In at least 30% of regenerated limbs the distribution of effector axons into bundles differed from the norm, a frequent difference being the presence of the very thin axon (4) in the closer axon bundle (C) instead of in the bender axon bundle (B); in other cases axons 1-3, to the opener and stretcher muscles, were found individually or grouped randomly amongst the other effector axons. Very often in regenerated limbs effector axons were intimately included in small sensory axon bundles.

So far the effector axon innervations of only the opener, closer, stretcher and bender muscles have been dealt with. Fairly large numbers of limbs were used in determining the innervations of these muscles. Relatively few limbs were used in determining the effector axon innervations of the three muscles situated in the manus, namely the extensor, flexor and accessory flexor. No experiments were made to isolate these axons functionally.

However the axons innervating the extensor flexor and accessory flexor were traced, starting from the points at which they left the main nerve trunk and tracing them from there in both directions. In six out of six extensor axon dissections, two axons of similar diameters to the two innervating the closer muscle innervated the extensor. In three out of six limbs a third axon was found innervating this muscle, but not running in close contact with the other two axons to it. It seemed probable that the presence of this third axon was the normal condition, as it could very easily have been pulled out

during dissection in the other three limbs. In four out of four flexor axon dissections, four axons were found to innervate the flexor muscle, the four axons running together in a compact bundle. No other axons to this muscle were found. In only three instances was any innervation of the accessory flexor muscle found, although it was not systematically looked for. In these three instances, only one axon was found to innervate it. This one axon divided into three distinct branches before reaching the muscle. These three branches entered the proximal portion of the muscle only, at about equal distances from each other and from the two ends of this proximal portion. No sign of any innervation of the distal portion of the muscle was found, although the two portions of the muscle appeared to be entirely distinct, being joined only by the thin rod-shaped tendon. Fig. 8b summarizes diagrammatically the effector axon innervations of the extensor and flexor muscles.

#### 3.4 FUNCTIONS OF THE EFFECTOR AXONS INNERVATING THE OPENER, CLOSER STRETCHER AND BANDER MUSCLES.

In order to determine the function of the effector axons found in the nerves, the axons were first isolated in the manner to be described, and then stimulated individually and in pairs to discover the effects of such stimulation on any one or more of the four muscles in the carpus and propus of the limbs. The descriptions and observations in this section refer primarily to normal unregenerated limbs. However the functional phenomena ascribed to each of these effector axons usually apply equally well to the axons in regenerated limbs, the main and

usually only difference being that the motor axons in the regenerated limb are displaced to a greater or lesser extent from their normal positions. This has been explained in section 3.3. However there are occasionally functional variations from the norm, and some of these will be dealt with in section 3.5.

#### 3.41 Procedure.

The limb, either cheliped or walking leg, was first severed from the live animal by cutting through the ischio-basipodite at the suture at which natural autotomy takes place when the limb is injured during the life of the animal. This was done with a single clean cut, using a pair of plier-type nail clippers, thus minimising the injury to the animal as the autotomy membrane soon formed over the proximal cut end. The severed limb was then washed under tap, and the dactylus pulled open and closed to pump out from the limb at the cut end as much as possible of the blood in the limb.

The central portion of the antero-ventral exoskeletal surface of the merus of the cheliped was then cut out with the nail clippers and scissors. The flexor muscle was removed, by freeing it around the whole of its extensive surface of origin inside the merus and cutting through the tendon at its articulation with the tendon platelet. The nerve lies immediately beneath this tendon platelet and beneath the flexor muscle itself; and immediately beneath the nerve lies the extensor muscle. This latter muscle was then removed by freeing its surface of origin from the inner surface of the merus and cutting

through the articulation between the tendon and tendon platelet. The nerve, together with the blood vessel lying alongside, was now free within the merus. The limb was then clamped with a thumbscrew type rubber tubing clamp, across the carpus and distal end of the merus so as to prevent any movement at the merus-carpus joint. The thumbscrew of this clamp was then secured in the jaws of a retort clamp, and the latter clamped onto a retort stand in such a way as to hold the opened surface of the merus facing upwards. The limb was then immersed in the physiological saline solution in a small shallow glass dish so that the saline just covered the exposed section of the nerve in the merus. The nerve was now ready to be split under the binocular microscope into its component bundles and axons.

First the blood vessel in the merus was separated from the nerve as described in section 3.3, and cut out and removed. The thin sheath covering the nerve, if it had not already been split open, was now split open and removed as far as necessary. Then, using the fine entomological pin needles described in section 2.33, the nerve was split into its component bundles. This was done by inserting the needle point between the bundles and gently pulling it along their length in the merus.

After splitting off each bundle from the rest of the nerve the bundle was tested for the presence of motor axons, by stimulating it. To do this the bundle was lifted on the hook of the cathode electrode and raised just above the surface of the saline solution. The liquid film between the nerve bundle and the surface of the

solution was broken by touching it with a small pointed piece of blotting paper held in the end of a drinking straw. The anode electrode was inserted into the fluid in the merus. Fig. 9 illustrates this set-up.

A negative-going square-wave repetitive-pulse stimulus from the oscillator described in section 2.42, of amplitude 0.1 - 5.0 volts, frequency 40 - 100s.p.s., and pulse duration 0.5 - 1.5 milliseconds, was then applied to the nerve bundle on the cathode. Usually the pulse frequency was kept constant at 50 c.p.s. and the pulse duration at 1.0 ,secs., and the pulse amplitude varied, if necessary, on each bundle between 0.1 and 2.5 volts, these values almost invariably being adequate to evoke a muscle response if there were any motor axons in the bundle being stimulated. If no muscle response was obtained this bundle was lowered into the solution again and another bundle was tried. Any nerve bundle, stimulation of which evoked a mechanical muscle response or responses, as indicated by the movement (s) of the joint (s), was marked by ligaturing it, as near to the cut end of the limb as possible, with a piece of human hair. The procedure was repeated until all the nerve bundles had been tested in this way, and marked if they produced any muscle response.

Usually in any normal unregenerated limb which gave mechanical responses from all four distal muscles the bundles which have been marked comprise three very small bundles of relatively thick and almost transparent axons. The first of these bundles comprises three thick axons of similar diameters; the second comprises two thick and one very thin axon; and the third comprises two thick axons

only. They can in fact be visually recognised as bundles A (axons 1-3), B (axons 4-5), and C (axons 7-8), respectively, described in section 2.3. In addition to these eight axons there may still be one or two bundles of sensory axons attached to one or two of the effector axon bundles. They may usually be distinguished from the effector axons by their longitudinally striated and rather opaque appearance, indicative of many very thin (sensory) axons. In some limbs, however, mechanical responses may be obtained only from the closer and bender muscles, although all the axon bundles may have been carefully tested. This may be because simultaneous stimulation of motor and inhibitory axons prevented opener and closer muscle responses. In this case responses from these two muscles may be obtained only on stimulation of the relevant axons separately.

These effector axon bundles were then split in a similar manner into their component axons. Each axon was then tested as the whole bundles had been tested, in order to find out which axons were motor axons, and which muscles the motor axons innervated. However, much greater care was needed here, as the single axons are extremely delicate, the slightest rough treatment being sufficient to "kill" the axon so that no further response could be elicited from the muscle innervated by it. Furthermore, after long periods of three or four minutes or so of stimulation of an axon in one spot, the axon gradually fatigued and became permanently "dead" to further stimulation at that point or at any other point nearer the cut end of the limb. In other words, a permanent "block" had been formed at the point of

stimulation, probably through permanent injury to the axon. Nevertheless, if the handling of the axon during stimulation had been sufficiently gentle, the axon sometimes regained its responsiveness if it was left undisturbed for an hour or more in the physiological saline.

In general, a stimulus intensity of 0.1 volts at a pulse frequency of 50 c.p.s. and a pulse duration of 0.5 msec. was sufficient to elicit a response from the muscle.

### 3.42 Excitation.

Stimulation of axon 1 of bundle A, which contains three axons all of about the same diameter, causes simultaneous opening of the dactylopedite and stretching of the propus. No response from any muscle is obtained upon stimulation separately of either of axons 2 or 3 of this bundle. Stimulation separately of each of the two axons 7 and 8 of bundle C causes closing of the dactylus. However the response to stimulation of the thicker axon (7) is considerably faster than the response to stimulation of the thinner axon (8), and the former response also fatigues more rapidly than the latter with a stimulus of long duration. In the same way, stimulation of the thickest of the three axons (axon 5) of bundle B causes fast bending of the propus, and stimulation of the middle-sized axon (6) causes slow bending. Stimulation separately of the very thin axon (4) of this bundle evokes no response from any of the four distal muscles.

Clearly these five axons, 1, 5, 6, 7, and 8 which elicit contractions in the four distal limb muscles, are motor axons.

It seemed probable that the three remaining axons are inhibitory.

### 3.43 Inhibition.

That the remaining three axons are inhibitory was shown by stimulating each one of them simultaneously with each of the five motor axons. For this purpose two cathodes with a common anode were used, as described in sections 2.432 and 2.433. The exciter axon being tested was first lifted out of the solution on one cathode, and then the axon to be tested for inhibition was lifted out on the other cathode. The same stimulus intensity, pulse frequency and pulse duration was used for both axons, namely 0.1 - 0.25 volts, 60 c.p.s. and 1.0 msec.

The motor axon was first stimulated alone to test whether it and the muscle were still responsive. Then the two axons were stimulated simultaneously. If the muscle still responded in the same way, either the non-excitatory axon was not the inhibitor axon for the muscle being tested, or this axon was temporarily or permanently "dead" at the point of stimulus or distally to this point. The possibility of the axon being "dead" could usually be eliminated by moving the cathode more distally on the axon past all points on the axon which appeared in any way damaged. If, on the other hand, the muscle response on simultaneous stimulation of the two axons was significantly less than the response to stimulation of the motor axon alone, or was absent altogether, the axon being tested for inhibition was an inhibitor for the muscle under observation.

Furthermore, if this inhibitor axon was stimulated for a short period during a long motor axon stimulus, partial or complete suppression of the contraction secured for the duration of the inhibitory stimulus, the contraction regaining its former tension soon after cessation of the inhibitory stimulus.

In this way it was found that stimulation of axon 2 causes inhibition of an opener muscle contraction evoked by simultaneous stimulation of axon 1, but does not cause inhibition of any other muscle contractions. Similarly, stimulation of axon 3 together with axon 1 causes inhibition of the stretcher muscle contraction. And finally, stimulation of axon 4, the very thin axon which innervates all four distal limb muscles, does in fact inhibit contractions of each of the four muscles by stimulation of each of the five motor axons innervating them. However the inhibition or suppression of contractions by stimulation of inhibitor axon 4 is seldom as complete as with inhibitor axons 2 or 3, and is sometimes very slight or even negligible. This will be considered later.

Thus axon 1 is a motor axon common to both the opener and the stretcher muscles, and is the only motor axon for these muscles. Axon 2 is the "specific" opener inhibitor; and axon 3 is the "specific" stretcher inhibitor. Axon 5 is a "fast" closer excitor; and axon 6 is a "slow" closer excitor. Axon 7 is a "fast" bender excitor; and axon 8 is a "slow" bender excitor. Axon 4 is an inhibitor common to all four of these muscles - the "common inhibitor". This "innervation pattern" is shown diagrammatically in fig. 13b.

E.44 Recording of excitation and inhibition.

The phenomena of excitation and inhibition described above could usually be observed qualitatively without recording the responses in any way. However it was desirable to have kymographic recordings of the various mechanical responses. These recordings also served to bring out some further points of interest.

No complete series from any one limb of kymograph recordings, showing the various responses of each of the four distal limb muscles to stimulation of each of their respective excitor and inhibitor axons, was obtained. This was because of the difficulty of manipulating single axons sufficiently delicately to avoid any injury which would impair their responsiveness, and also because even with very little manipulation of the axons the limb preparation seldom remained responsive for sufficiently long periods (8 - 10 hours) to enable a complete series of recordings to be obtained. The difficulty of manipulation applied in particular to the common inhibitor axon. The two cathode manipulator-holders which were being used for this work were in fact too clumsy.

The nearest to a complete series of recordings was one obtained using a walking leg, in which recordings of all the muscle responses except those of the closer muscle were obtained. A number of less complete series of recordings were obtained, in all from four cheliped preparations and seven walking leg preparations. No qualitative or quantitative differences between chelipeds and walking legs were found.

In order to give some indication of the relative mechanical responses to stimulation of the different effector axons, extracts from kymographic records made of the various responses of the walking leg which gave the most complete series are shown in fig. 10 and 11, together with closer muscle responses from another walking leg. These records are fairly representative. Although the closer muscle records chosen were made from a walking leg which had three closer motor axons, the mechanical responses obtained from the thickest and intermediate closer motor axons of this limb are not atypical of the "fast" and "slow" closing responses respectively, of normal limbs.

As is described in the legends of figs. 10 and 11, there were important differences in the conditions of stimulation and recording used in obtaining these records. These experimental differences introduced differences in the recorded mechanical responses which are largely irrelevant to the present comparison between the effects of stimulation of the different effector axons, but must be pointed out to avoid confusion. The initial rates of development of tension in the closer muscle recorded in fig. 10 (e and f) appear markedly greater than those in the bender muscle. This is not due to differences between the muscles, or to the different stimulation conditions, but is due simply to the recording lever pointer being directed slightly upwards at zero displacement, instead of slightly downwards as for the other three muscles. The rapid fatigue recorded for the thick closer motor axon was due to the high amplitude of motor axon stimulation, since this does not occur at low amplitudes of stimulation. For

Fig. 10.

Kymographic records of mechanical responses of the joints of walking legs to stimulation of the motor axons. Records a-d were made from one walking leg, and records e,f from another, of a different crab.

- a opening : opener-stretcher motor axon
- b stretching : opener-stretcher motor axon
- c bending : "fast" bender motor axon
- d bending : "slow" bender motor axon
- e closing : "fast" closer motor axon
- f closing : "slow" closer motor axon

Square-wave repetitive-pulse stimulus applied to each motor axon :

- a,b 0.1 volts, 45 c.p.s., 1.5 msec. pulse duration
- c,d 0.1 volts, 120c.p.s., 1.5 msec. pulse duration
- e,f 0.25volts, 45 c.p.s., 1.5 msec. pulse duration

Time : 5 seconds

Fig. 11.

Kymographic records showing inhibition of mechanical responses to motor axon stimulation, caused by stimulation of the respective inhibitor axons. These records were made from the same two walking legs as the records in fig. 10.

- a,b inhibition of opening by (a) specific opener inhibitor  
(b) common inhibitor
- c,d inhibition of stretching by (c) specific stretcher inhibitor  
(d) common inhibitor
- e,f inhibition, by common inhibitor, of (e) "fast" bending  
(f) "slow" bending
- g,h inhibition, by common inhibitor, of (g) "fast" closing  
(h) "slow" closing
- i slow closing caused by stimulation of the thinnest of the three closer motor axons from which g,h,i. respectively, were obtained; also shows inhibition by common inhibitor

Square-wave repetitive-pulse stimuli applied to both motor axon and inhibitor axon of each record

- a,b;and c,d as in a;b of fig.10
- e,f as in e;d of fig.10
- g,h,i as in e;f of fig.10

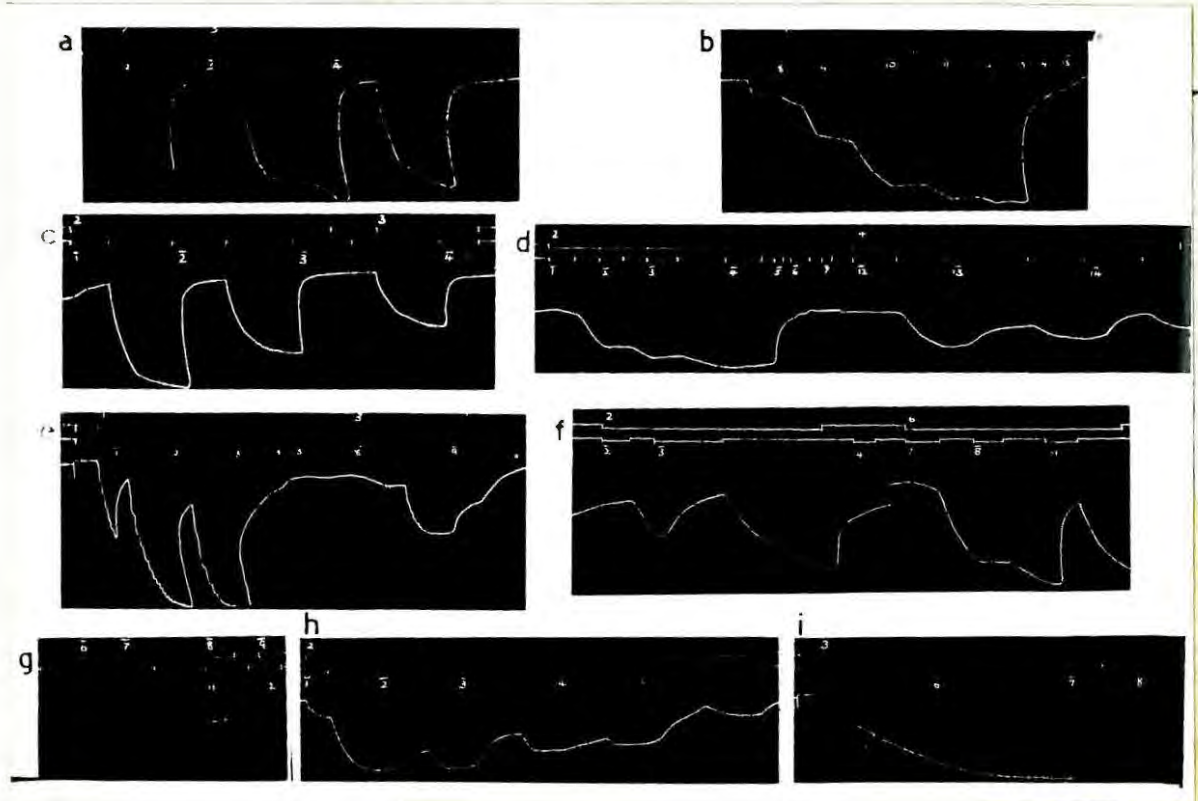
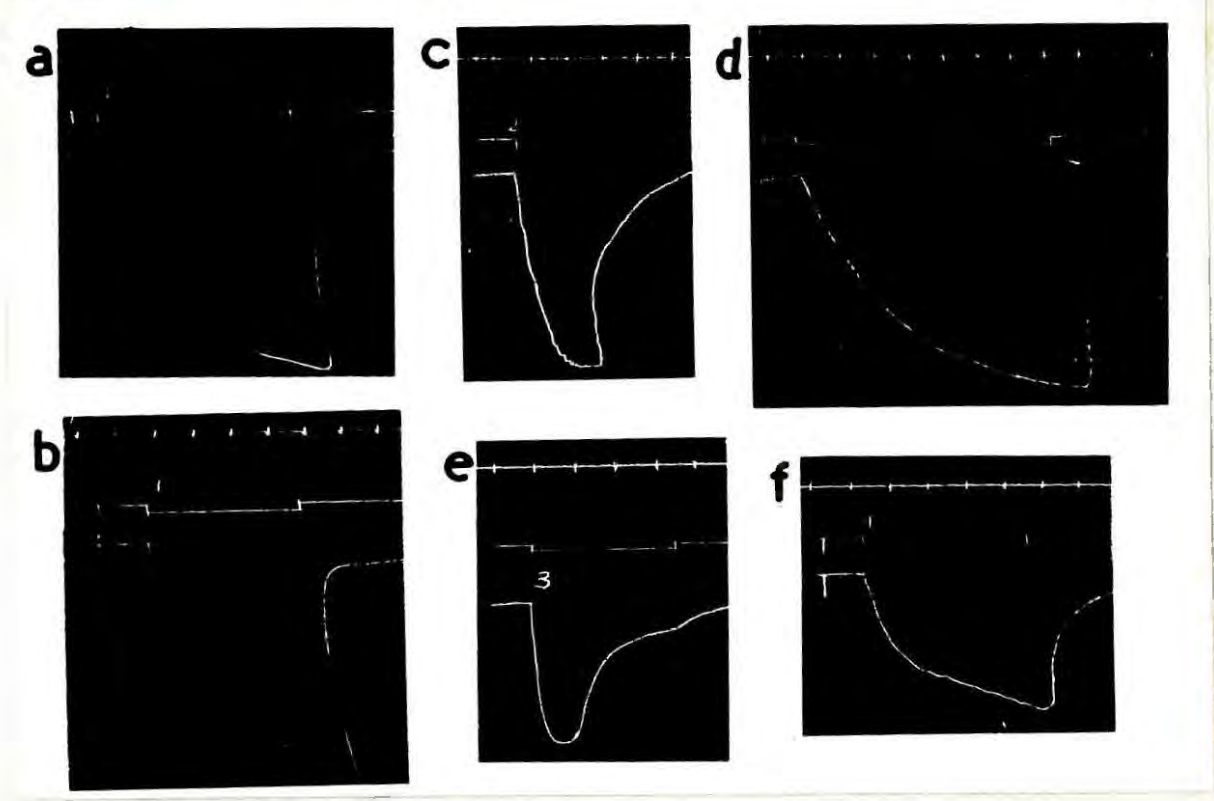

similar reasons the rapid bender fatigue in fig. 10 (c) was due to the high frequency (120 c.p.s.) of motor stimulation.

The following generalisations on the behaviour of the four distal muscles on stimulation of their various effector axons are drawn from all the relevant kymographic recordings, which are exemplified by those shown in figs. 10 and 11.

There are three distinct types of mechanical response which are obtained from the four distal limb muscles upon stimulation of the respective motor axons: (a) the responses of the opener and stretcher muscles; (b) the "fast" responses of the closer and bender muscles; and (c) the "slow" responses of the closer and bender muscles. Within each of these three pairs the two responses are very similar. Both the "fast" and "slow" responses of the closer muscle have the same maximum tension, as do those of the bender muscle.

The mechanical response of any of the four muscles begins almost immediately on commencement of stimulation of one of its motor axons. In response to stimulation of the "fast" closer or bender axon, the muscle contracts very rapidly, and quickly reaches maximum tension. On the other hand, when the "slow" closer or bender axon is stimulated, the muscle contracts slowly, and takes a considerable time to reach maximum tension. The response of the opener or stretcher muscles to stimulation of the motor axon is intermediate between the "fast" and "slow" responses of the closer or bender muscles. The muscle contracts fairly rapidly at first, though not as rapidly as in the "fast" contractions, and then gradually more slowly, and it takes

a considerable time to reach maximum tension, though not as long as the "slow" contractions. If the motor axon stimulus is maintained, the "fast" responses soon fatigue, but the "slow" responses and also the opener and stretcher responses, may be maintained for 2 - 5 minutes. These observations apply within the limits of stimulus pulse amplitude, frequency and duration used in the present investigation, namely 0.1 - 0.25 volts, 40 - 120 c.p.s., and 0.5 - 1.0 msec., respectively.

Within the same limits of stimulus pulse values, the degree of inhibition or suppression of a muscle contraction caused by stimulation of the three inhibitors differs. A stimulus applied to the opener or stretcher inhibitor axon, during motor axon stimulation with the same pulse values, causes complete suppression of the contraction, that is, reduces the recorded muscle tension to 0% of its uninhibited value. With similar pulse values, the inhibition or suppression caused by stimulation of the common inhibitor of a contraction of any of the muscles innervated by it is seldom complete.

The degree of inhibition by the common inhibitor of contractions evoked by stimulation of each of the five motor axons differs, also. The common inhibitor is equally effective in inhibiting or suppressing (a) the contractions of the opener and stretcher muscles; (b) the "fast" contractions of the closer and bender muscles; and (c) the "slow" contractions of the closer and bender muscles. Its effectiveness differs, however, between each of these three pairs, the order of decreasing effectiveness being : (c)-(a)-(b). At stimulus pulse values of 0.1 volts, 45 c.p.s., and 0.5 msec., stimulation of the common in-

-hibitor axon during motor axon stimulation suppresses these three groups of contractions, reducing the recorded muscle responses to the following very approximate percentages of their uninhibited values: (a) 80 - 50%; (b) 95 - 75%; and (c) 50 - 10%. Greater degrees of inhibition are obtained, in particular with the "fast" closer or bender axon, with greater frequencies of inhibitor axon stimulation, at least up to 120 c.p.s., although the frequency of motor axon stimulation is kept the same as that of inhibitor stimulation (e.g., fig. 11, e and f). Unfortunately, owing to lack of two identical square-wave stimulators, no observations were made on R<sub>c</sub> values.

### 3.5 ANATOMICAL AND FUNCTIONAL ABNORMALITIES.

In 5-8% of the limbs investigated the two closer motor axons were of almost indistinguishable diameters. These diameters were comparable with the average diameter of the opener-strecher excitor axon, which is intermediate between the average diameters of the "fast" and "slow" closer axons. The mechanical responses, both excitatory and inhibitory, recorded from this closer muscle, (fig. 12) were very similar for the two axons, and closely approximated to the average excitatory and inhibitory responses recorded from the opener and strecher muscles with the common inhibitor. Usually when this peculiarity of the closer excitor axons occurred, the same peculiarity was found in the bender excitor axons of that limb. Unfortunately it was not discovered whether the same peculiarity occurred in some or all of the other limbs of the one animal.

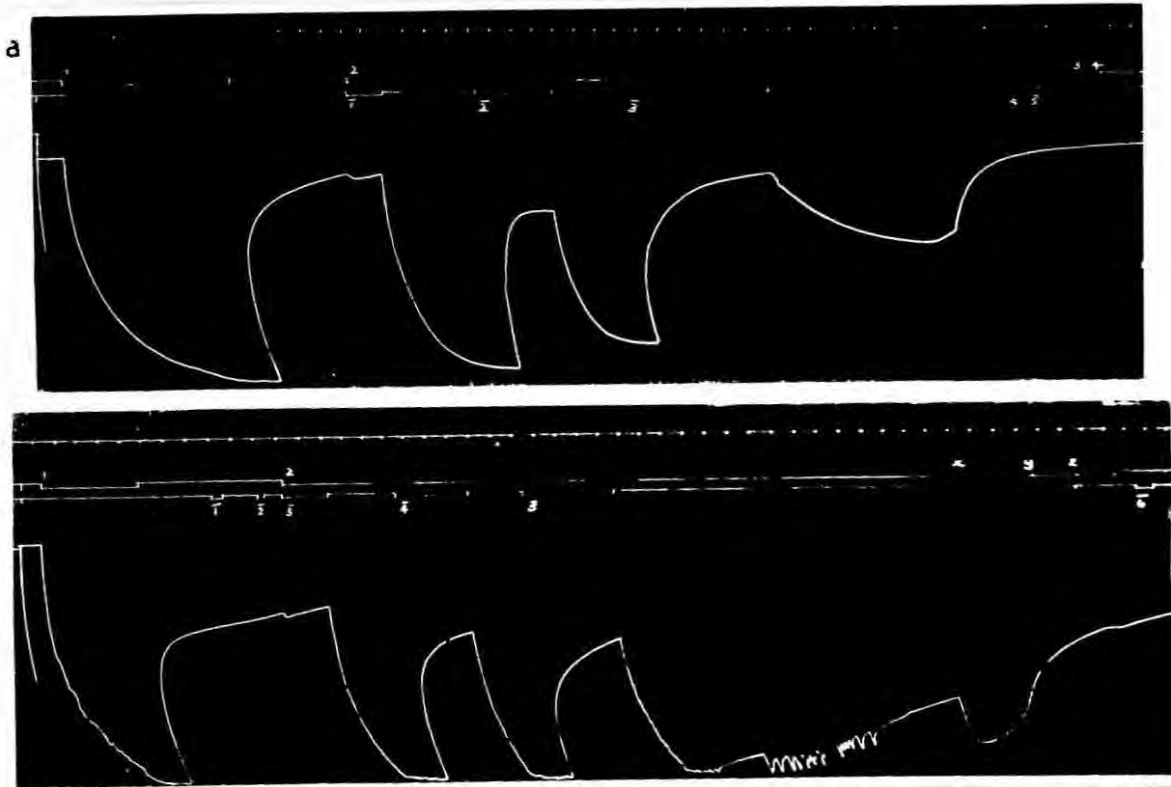

Fig. 12. Closing responses of a cheliped to stimulation of the two motor axons, which were of almost indistinguishable diameters. Inhibition by common inhibitor axon also shown. Stimuli : 0.1 volts, 45 c.p.s., 1.5 msec. At x : 0.25 volts, to end. Time : 5 seconds.

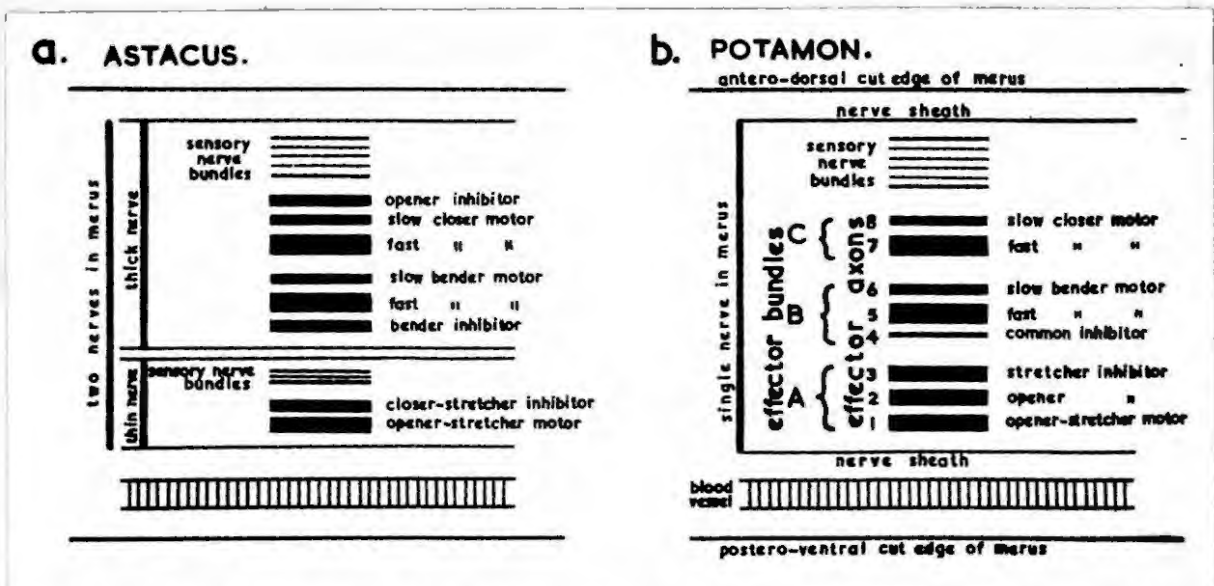

Fig. 13. Diagram showing the differences in effector axons and their distribution, as seen in the dissected merus, between Astacus and Potamon. The function of each axon is also given. (C.f. fig. 8).

In 2 - 3% of the limbs investigated, both chelipeds and walking legs, there were three closer motor axons. Their diameters were all different, the thickest and middle-sized axons having diameters similar to the thick and thin closer axons, respectively, in normal limbs and the thinnest being only slightly thinner than the middle-sized axon. In this limb the rate of contraction of the closer muscle in response to stimulation of each of these three axons decreased in the order of decreasing diameters, and the effectiveness of inhibition increased in this order (fig. 11; g, h, i). In this particular limb the bender muscle had only two excitatory axons, of about average diameters.

### 3.6 CONCLUSION.

The effector <sup>axons</sup> innervating the intrinsic muscles of the chelipeds and walking legs of Potamon perlatum are summarised diagrammatically in fig. 8, and the functions of the effector axons innervating the four distal muscles are summarised in fig. 13b. No difference has been found between the innervations of the chelipeds and those of the walking legs in P. perlatum. This is in agreement with the findings of Wiersma et al in other Brachyura and other tribes of Decapod Crustacea. The axon innervations and their functions for the four distal limb muscles of P. perlatum are the same as described by Wiersma and Ripley (1952) for all species of Brachyura in which the axon innervations and functions had been established.

Unfortunately a physiological investigation of the functions of the axons innervating the flexor and extensor muscles of the limbs

of P.perlatus has not been made. However, there are in P.perlatus as in the other species of Brachyura studied, three axons innervating the extensor muscle, of similar relative diameters to those innervating the extensor of the other Brachyura. There are at least four axons innervating the flexor muscle of P.perlatus of similar relative diameters to four of the five axons innervating the flexor of other Brachyura. Furthermore, it is possible that there is a fifth axon innervating this muscle in P.perlatus, namely a branch of the opener inhibitor axon, since in the relatively exposed position in which the opener-strecher axons lie in the merus these axons could easily have been unwittingly pulled out in dissecting the nerve in the ischiopodite. If there is this fifth axon to the flexor of P.perlatus, then the innervation of the flexor of P.perlatus is the same as the innervation of the flexor of other Brachyura. As in the other Brachyura studied, there is in P.perlatus only one axon innervating the accessory flexor muscle (not shown in fig.8).

Thus all major findings on the axon innervations and functions for the seven distal limb muscles of Potamon perlatus are in agreement with those of Wiersma et al on all the species of Brachyura which they have studied. Furthermore, because of the homogeneity of axon innervations and functions amongst other Brachyura (Wiersma et al) and because of the exact correspondence in innervation and function of the axons of the four distal limb muscles of P.perlatus with those of the other Brachyura studied, it is highly probable that the axon innervations and functions of all seven intrinsic limb muscles of P.perlatus are the same as those of the other Brachyura.

The mechanical responses obtained on stimulation of the various motor and inhibitor axons of the four distal limb muscles in Potamon perlatius are broadly similar to those of other Brachyura and other Decapod Crustacea described by Niersma et al.

Niersma has shown that the characteristics of the "fast" response are distinguished from those of the "slow" response by different extents in different Decapod Crustacea. Thus, in Cambarus clarkii and Astacus trochridgii, whose two motor axons are markedly different in diameter, stimulation of the thick and thin closer motor axons evokes "fast" and "slow" closer responses, respectively, with distinctly different mechanical and electrical properties (van Harreveld and Niersma, 1936). The most obvious difference is that a sharp twitch contraction occurs on stimulation of the thick fibre, even with only one motor impulse, whereas a slow smooth tetanus develops on stimulation of the thin fibre, and then only after several stimulatory pulses. On the other hand, in Hanger pagurus and Carcinus maenas whose two closer motor axons are not markedly different in diameter, the "fast" and "slow" contractions are not easily distinguishable (Niersma and van Harreveld, 1938). However, there is, within the species Potamon perlatius itself, considerable individual variation in these mechanical responses. In the first place there are varying degrees of difference between "fast" and "slow" contractions. The most common condition is that in which the two closer axons are of distinctly different diameters. The "fast" closing response was markedly sharper and more rapid than the smooth tetanic "slow" response, but nevertheless could not be evoked by only one or two stimulatory pulses. In

the not uncommon condition in which the two closer axons were of comparable diameter, however, the two responses were mechanically hardly distinguishable, and each was more or less intermediate between the "fast" and "slow" responses of the normal condition. In a more uncommon condition, in which there were three closer motor axons of different diameters, the middle one evoked mechanical responses intermediate between the "fast" and "slow" type responses of the other two.

The "fast" and "slow" closer motor axon systems of Potanon and possibly also of Bassor and Garcinus, are thus sufficiently unspecialised and variable functionally to exemplify the sort of condition from which might have developed the highly specialised fast twitch and slow tetanic contraction systems of the closer of the astacurans, Cambarus and Astacus, and the natantian, Stenorius, in which a single stimulatory shock to the fast closer axon results in a maximal twitch of the muscle (Wiersma and Ripley, 1952).

Stimulation of the opener-strecher motor axon in Potanon, which is more or less intermediate in diameter between the "fast" and "slow" closer axons, evokes an opening response which is intermediate in character between the "fast" and "slow" closer contractions. Of interest in this connection is the condition in the anemuran, Amphicurus bernhardus, in which both "fast" and "slow" types of contractions, though not the most extreme forms of these two types, can be independently evoked in the limb opener muscle, by stimulation, at high or low frequencies, respectively, of the single opener motor axon (Wiersma, 1951). The presence of two types of motor nerve endings on each muscle fibre is postulated as the most likely explanation of this phenomenon.

44a.

This "bifunctional single axon system" may be considered as a development of the more common unifunctional single axon system. The single axon opener motor system of Potamon, with more or less intermediate mechanical response characteristics, exemplifies the sort of relatively unspecialised condition from which the condition in Hexagramus might have developed.

The degree of inhibition caused by stimulation of the common inhibitor in Potamon, of a contraction evoked by motor axon stimulation, is related to the diameter of the motor axon being stimulated. The common inhibitor inhibits a "slow" closer or bender contraction more than an opener or stretcher contraction, and an opener or stretcher contraction more than a "fast" closer or bender contraction; it does, moreover cause a distinct inhibition of a "fast" closer or bender contraction, even at the same and low stimulation frequency. This again indicates the more or less unspecialised condition of these motor axon systems of Potamon.

Thus the opener and closer axon innervation pattern of Potamon both anatomically and functionally, represents a fairly general and unspecialised condition such as might be expected to have given rise, by development and specialisation, to the more specialised conditions seen in the actinurans, Bamburus and Astacus, and the encyren, Hexagramus. This suggests that the Brachyura, in this respect at least, are not as specialised as the other two Reptantia tribes mentioned here. If it is assumed that the various inhibitory axon innervation patterns of the four tribes of Reptantia evolved from a fundamental pattern consisting of a single common inhibitor axon innervating all the intrinsic muscles of a limb (c.f. Vierasma and Ripley, 1952), then a comparison of the inhibitory axon innervation patterns of the four Reptantia tribes, from a purely anatomical point of view, leads to a similar suggestion. Only the Palinura and Brachyura

have retained a common inhibitor axon, innervating all but one and two respectively, of the seven most distal limb muscles. The Palaestra are even less specialised than the Brachyura in their inhibitor innervation patterns. Nevertheless the point remains that the Brachyura do not appear to be highly specialised either anatomically or functionally, in their limb axonal innervation patterns.

There is a considerable difference, both in the arrangement of the effector axons in the nerves, and in the innervation of the four distal limb muscles, between Potamon verlatius and Astacus fluviatilis on which latter animal Hoffmann (1914) carried out his experiments. These differences are summarised diagrammatically in fig. 13. As a result of these differences various difficulties were encountered in the present experiments on Potamon which were not encountered in the experiments of Hoffmann on Astacus. These difficulties will be described in section 5.0.

#### 4.0 METHODS IN EXPERIMENTS ON REFLEX CLAW OPENING.

##### 4.1 Mounting the animal for experimentation.

In mounting the animal for experimentation there were three main requirements.

- 1 Each of the two cheliped meri had to be held in such a position as would facilitate dissection, exposure of the nerve and manipulation of the electrodes on the nerve in the merus. Furthermore, since it was impracticable to work with the whole animal or even the whole cheliped immersed in physiological saline solution, the cheliped merus should be held in a position in which, once its flexor muscle had been removed to expose the nerve, the merus could hold sufficient saline to keep the exposed portion of the nerve immersed therein. The most practicable orientation of the merus was therefore with the antero-ventral surface, which was the surface to be opened for dissection, facing vertically upwards, with the cheliped held extended outwards from the body.

2. Each dactylus should be free to move normally and in a position to facilitate recording of opening and, preferably, closing, also.

3. The abdomen should be in a position where it was readily available for sensory stimulation.

The crab was therefore mounted on a board with dorsal surface down in contact with the board, and with chelipeds held extended. The mounting board consisted of a symmetrical-rhombhedron shaped piece of tempered masonite, 4mm. thick, 20 cm. long, 20 cm. wide along

the anterior edge, and 12cm. wide along the posterior edge. On the upper surface along each lateral edge of this board was nailed a piece of wood 3cm. wide and tapering in thickness from 18mm anteriorly to 8mm. posteriorly. Holes 2mm. in diameter, were bored through these lateral pieces of wood and through the masonite beneath them. A third piece of wood was nailed on the under surface of the masonite board along the anterior edge to facilitate holding the board in two retort clamps clamped on to this piece of wood at right angles to its length.

The crab was mounted, dorsal surface down, on the upper surface of the masonite board between the two lateral blocks of wood, and held in position thus with a single strand of 0.7mm. in diameter electrical cable wire passing over the ventral surface of the crab just anterior to the coxa of the chelipeds and laterally over the branchiostegite, and threaded through two holes in the masonite, the two ends of the wire being then twisted tightly together underneath the board. Each cheliped was firmly held extended and resting upon the lateral wooden block by means of a piece of the same electrical wire around the carpus and another one or two or three pieces, depending upon the strength of the cheliped, around the propus, leaving the dactylus free to open and close completely. The walking legs were held straight out sideways by two more pieces of wire.

The preparation board was held at the anterior edge by two retort clamps, fixed by X-blocks to a vertical retort stand at an angle of about  $45^{\circ}$  to the horizontal, so that the ventral surface of the crab faced the experimenter. In this way the antero-ventral

surface of each merus was facing vertically upwards, and the abdomen of the animal was nearest the experimenter. The retort stand was nearest the anterior end of the crab, that is, away from the experimenter.

Underneath the preparation board a rectangular plastic dish 12 x 12 x 12 cms., was placed to catch any water or saline running off the preparation. A rubber outlet tube from this dish ran off the bench into a vessel on the floor, so that any liquid running off the preparation would not accumulate in the dish.

#### 4.2 KYMOGRAPHIC RECORDING OF OPENING OF THE CHELIPED DACTYLI.

Two small Palmer pulleys were clamped, with metal rods and Palmer X-blocks, to the retort stand, and held in position for the two recording lever threads to record opening of the two dactyli by a downward pull on the non-recording ends of the two recording levers. Thus opening of each dactylus was recorded on the revolving smoked kymograph drum by an upward deflection of the recording lever pointer.

#### 4.3 SENSORY STIMULATION.

Two types of sensory stimulation were used in evoking a reflex opening response in the dactyli, namely mechanical and electrical. No particular form of either type was consistently successful in evoking reflex claw opening, so that it was necessary to use whatever form of mechanical or electrical sensory stimulus was successful for the individual crab. This meant that results were not all directly comparable.

For most forms of abdominal stimulation the abdomen was opened outwards and held in a fixed position in one of two ways.

1. The abdomen of female crabs was opened to an angle of 50 to 60 degrees to its normal closed position and held in that position by allowing the inside surface of the last or the penultimate segment to rest against the horizontal portion of an inverted-U-shaped piece of 3mm. diameter wire. This wire was anchored in position by inserting each end into one of the many holes in each of the two lateral wooden blocks on the mounting board. The intersegmental flexor muscles and elastic ligaments at the base of the abdomen keep the abdomen pressing firmly against this wire, so that the abdomen was held fairly firmly and rigidly. This method of holding the abdomen out was used mainly in the earlier experiments.

2. In the other method, which was mainly used in the later experiments, the abdomen was opened to an angle of 100 to 120 degrees in female crabs and 120 to 150 degrees in male crabs. The outside (i.e. anatomically dorsal) surface of the abdomen rested on a wedge shaped wooden block which was fixed temporarily to the mounting board by a piece of wire. The abdomen was held in this position by two drawing pins stuck into the wooden wedge, one on either side of the penultimate abdominal segment, and by a small rubber band holding down the last segment.

4.31 Mechanical sensory stimulation.

Four forms of this were used with some success.

1. "Stroking" the crab ; (a) with the rounded end of a brass or glass rod; or (b) with a small U-bend in a piece of thin wire attached to the end of the titillator (described in section 2.41). The crab was stroked either (c) transversely across the intercoxal sternal plate of the cheliped segment; or (d) on the outer or inner surface of the abdomen; or (e) in female crabs, along the length of the plate-like pleopod, either dorsal or ventral surface.

2. Pinching or pressure on the open abdomen. When the abdomen was held open against the U-shaped wire, it could be pinched around the edge with forceps. When held open against the wooden wedge, pressure could be applied on the inside (i.e. anatomically ventral) surface, either unilaterally or bilaterally on either side of the rectum, using forceps or the handle of a dissecting needle.

3. A high frequency hammer stimulus could be applied with the titillator hammer. This could be applied almost anywhere on the animal, including the outside surface of the abdomen while held open against the U-shaped wire, or the inside surface of the abdomen while held open against the wooden wedge.

4. High frequency vibration with the titillator, of the tip of the abdomen in the mid-sagittal plane. The tip of the abdomen was gripped in a small inverted-U-shaped wire hook attached to the hammer of the titillator.

In neither 1 nor 2 was it possible to maintain a constant intensity of stimulus, either for the duration of a single stimulus or for consecutive stimuli. These two methods were therefore not much used. Various other methods of applying a mechanical sensory stimulus were tried but none with any great success. Stroking or lightly tapping the crab in the following places was sometimes successful in evoking a reflex opening response in one or both claws: on the outer surface of the third maxilliped; on the antero-lateral surfaces of the branchiostegal covering; on the ventral surface of the cheliped propodite, in particular on the immovable propodite ramus; and across the bases and coxopodites of the walking legs. Pinching the animal on the maxilliped exopodites was also sometimes partly successful.

Clearly reflex opening of the claws is a response, defensive in character, which is fairly readily evoked by "harmful-seeming" sensory stimulation over a fairly general area of the body, at least on the anterior, lateral and ventral surfaces of the body. Tactile stimuli on the dorsal surface of the carapace also evoke reflex claw opening, though not as readily or strongly as do tactile stimuli on the abdomen or on the antero-ventral surfaces of the body.

#### 4.32 Electrical sensory stimulation.

This was applied by means of the electronic square-wave stimulator B described in section 2.42, and the electrode pair described in section 2.43 (1). Electrical sensory stimuli which

were successful in evoking an opening response in the claws were of three main types : (1) localised abdominal stimuli, with voltages usually between 5 and 20 volts; (2) localised "rostral" stimuli, with voltages of 5 to 20 volts; and (3) general stimuli, on various parts of the body, with voltages of 20 to 50 volts.

1. The localised abdominal stimuli were applied with the two electrodes placed 1 - 5mm. apart, on various parts of the inside surface of the opened abdomen. Usually, the electrodes were placed near the tip of the abdomen, but sometimes on the smooth surface of the penultimate segment, or on one of the intersegmental membranes, or on the dorsal or ventral surface of the plate-like exopodites of the pleopods.

2. The localised "rostral" stimuli were applied with the two electrodes placed 1 - 5 mm. apart on the exoskeleton just dorsal to the small rostral protruberance, which itself is just dorsal and external to the cerebral ganglion of the crab. Sometimes one or both the electrodes were placed in one of both of the basal pits of the antennules.

3. The general electrical stimuli were applied with the electrodes placed 5 - 15 mm. apart, in one of three regions :

(a) on any of the abdominal surfaces as in (1) above;

(b) on the supra-rostral surface as in (2) above; or

(c) with the cathode on the supra-rostral surface and the anode at varying distances from it in various positions on the ventral or anterior surface of the body.

The stimuli applied as in (c) were almost invariably successful in evoking either opening or closing of one or both claws when the anode was in some soft spot posterior to the cathode, for example,

in the soft coxal socket region of the cheliped, or on the soft inside surface of the abdomen. That these stimuli were more or less general stimuli to the neuromuscular system is indicated in a later section (6.3), with a description of the effects of this type of stimulation.

Other methods of applying localized sensory stimuli were tried but none were successful. Among these were direct stimulation, using straight or hook-shaped electrodes and voltages of 0.5 - 20 volts, (a) of the abdominal sensory nerves at the base of the abdomen on its inside surface; (b) of the nerve in the merus of each of the walking legs; and (c) of the nerve in the merus of one of the chelipeds. This failure to obtain any opening reflex by direct stimulation of the sensory nerves coming from the general regions in which mechanical or surface electrical stimulation was effective in evoking reflex opening is difficult to explain. It may conceivably be that the sensory axons, even while still in their original bundles, require considerably more delicate manipulation on the electrodes than the motor axons. On one occasion, however, a single slight opening response was obtained from the right cheliped/<sup>on</sup> direct stimulation of the whole nerve in the merus of the left cheliped, using a stimulation amplitude of 1.0 volts at a pulse frequency of 100 c.p.s. and pulse duration of 3.0 msec. Further attempts to obtain a similar reflex opening response failed, however.

#### 4.4 EXPOSING AND ISOLATING THE EFFECTOR AXONS OF THE CHELIPED.

It was found with intact animals that if nothing was done to prevent it, a cheliped was autotomised within 5 - 10 minutes after

beginning to open the merus and dissect out the flexor muscle. Various attempts at preventing this autotomy of the chelipeds were tried; for instance, firmly tying down with wire the basipodite and the coxopodite, with the idea of preventing their movement. This was unsuccessful. Cooling at 10 C for 1 - 1½ hours before dissecting was also unsuccessful. It was eventually found that cutting the ligaments of the two muscles in the coxopodite at their articulations with the basipodite prevented autotomy of the cheliped. Evidently these were the autotomy muscles, but their contraction also had the effect of raising the basipodite. The loss of blood caused by this operation was very small, and it apparently produced no ill-effects on the claw opening reflex. In all subsequent experiments, therefore, these autotomy muscle tendons in both claws were cut at their articulations before mounting the animal on the preparation board.

The merus of the cheliped to be dissected was opened in the usual way, by cutting out the antero-ventral exoskeletal surface, as described in section 3.4. The flexor and accessory flexor muscles were then removed under the binocular microscope as before. Until the latter stages of these experiments the extensor muscle was not removed, as in the initial stages of the work this was found to be a cause of injury to the motor axons, which although very slight, was yet sufficient to block through-conduction in the opener excitor axon resulting from sensory stimulation. However, leaving the extensor muscle intact in the merus made it difficult to distinguish visually the motor axons in the nerve from the sensory bundles, particularly from the small ones lying in the region of the motor axons. Consequent -

-ly during the later stages of the work when sufficient manipulative ability had been attained, the extensor muscle was removed, after removing the flexor muscle and ligaturing the blood vessel.

Initially during these experiments, the chelipeds were not perfused with physiological saline, but simply washed out at fairly frequent intervals with a slow jet of saline from a compressible plastic bottle. The blood vessel of the limb was left intact in the merus, so that a continual blood flow was maintained to the distal limb muscles. The flow of blood in the vessel could usually be observed through the binocular microscope; it was pumped at a rate of about 1.5 pulses per second for a period of 15 to 25 pulses, followed by a rest of about 5 seconds, after which the cycle was repeated. However, during the course of an experiment, the rate of flow of blood became slower and slower, partly due to the excessive loss of blood from the opened merus, and partly due to the blood coagulating slowly in the vessel in the merus and probably also in the distal muscles in the merus. <sup>4</sup> It was probable that this reduction in the blood flow and partial coagulating of the blood in the distal limb muscles was partly responsible for the chelipeds gradually becoming less responsive to sensory or motor axon stimulation more rapidly than with the individual limbs in the preliminary experiments. Consequently after the early stages of the work the two chelipeds were always perfused during the course of an experiment.

Immediately after removal of the flexor muscle in each cheliped, the blood vessel was ligatured at the proximal end of the merus, using a piece of human hair. The tip of the immovable ramus of

the claw was then cut off and a thin rubber perfusion tube slipped firmly over this cut end. This rubber tube was connected to a longer piece of polythene tubing from a bottle in which the perfusion saline was kept. The level of the saline in the bottle was maintained so that the rate of flow of saline through the cheliped remained constant and fairly slow. This was done for both chelipeds. Both were supplied with saline from the same bottle, using a Y-piece to divide the perfusion tube into two branches, each branch having its own screw clamp to adjust the rate of flow through it.

In a normal unregenerated cheliped it was usually possible to distinguish under the binocular microscope, the motor axon bundle containing the three axons to the stretcher and opener muscles. Usually this was also possible, though with some difficulty, in a regenerated cheliped. This bundle was then carefully isolated from the rest of the nerve, using the entomological pin needles, and split into its individual axons, using the flattened sharp two-edged needle mounted in a glass handle. The three axons were then ready to be tested individually, by direct stimulation, to identify the opener motor and specific inhibitor axons, since it was not possible to identify them visually. This was necessary before the main part of the experiment, on reflex claw opening, could be commenced.

The whole experimental set-up, for mechanical abdominal sensory stimulation and electronic cheliped axon stimulation, is shown in fig. 14.

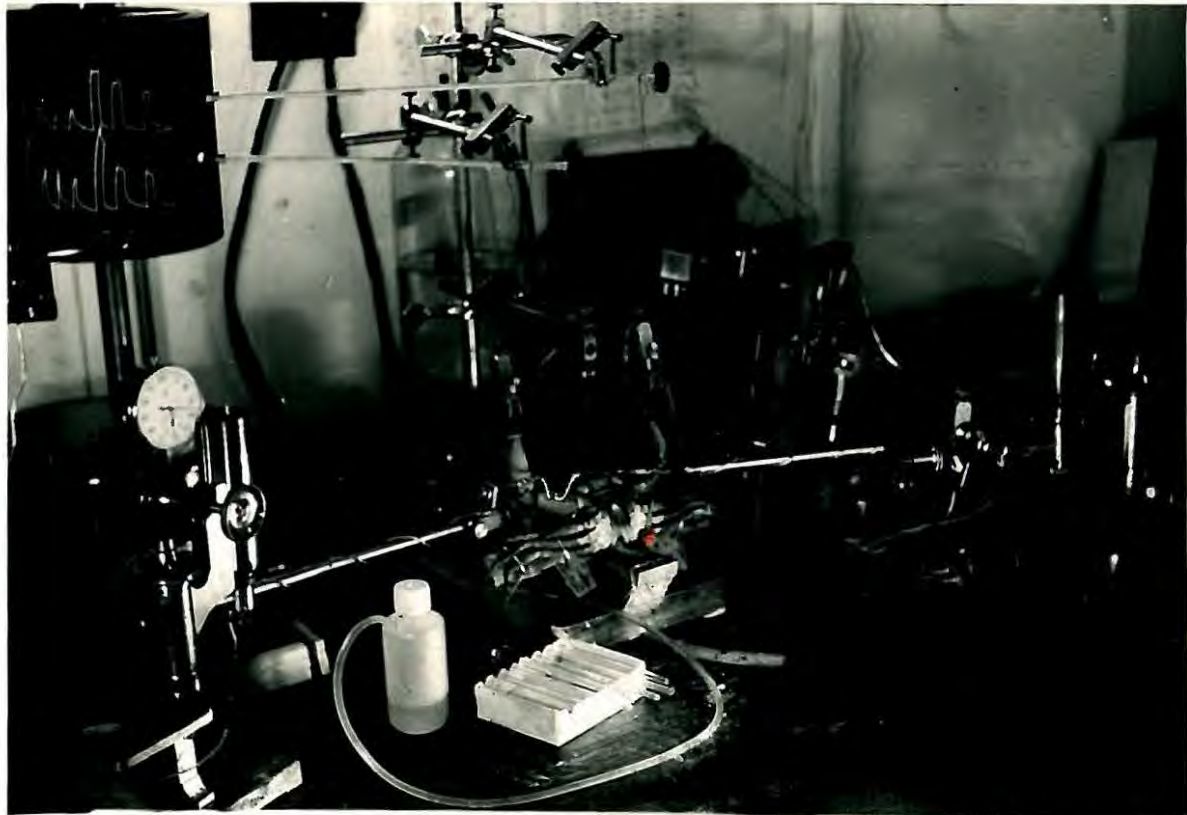

Fig. 14.

Experimental set-up for mechanical abdominal stimulation, electronic stimulation of the effector axons in the nerve of the right claw, and kymographic recording of reflex opening of both claws. The crab is mounted with wire on the mounting board in the usual way. Each cheliped is perfused through the perfusion tubes from the saline bottle in the background. The dish and tube for draining off the saline is in place beneath the preparation. The "titillator" (converted Du-Bois Reymond induction coil) is in position on the right and above the preparation. The electrode micromanipulator is to the right of the titillator. The universal bearing electrode holder is on the left.

#### 4.5 DISAPPEARANCE OF THE CLAW OPENING REFLEX.

In many experiments during one stage of the work, the claw opening reflex was found to have disappeared during the course of the dissection process. This was the cause of repeated failures of experiments. Usually it occurred while separating the opener-strecher axons, but sometimes while removing the extensor muscle, sometimes while separating off the blood vessel from the nerve, and sometimes even when removing the flexor muscle. Occasionally, however, the opening reflex reappeared 1 - 4 hours after isolation of the axons. Three possible causes of the disappearance of the opening reflex were suggested.

1. It could possibly have been due to motor fatigue resulting from strong stimulation of the opener excitor axon in the merus by the dissection process.

Three experiments were made partly to test this possibility. The opener axon of a claw was stimulated repetitively in the merus for 5 seconds every 2 minutes over a continuous period of 30 to 50 minutes....

fig. 15. After 30 minutes of repetitive stimulation there was slight fatigue of the opening response in two of the three experiments, and after 40 minutes there was somewhat more fatigue in all three experiments, resulting in a response height of 30 - 50% of the starting height. The dissection process in the reflex claw opening experiments, comprising opening the merus and removing the flexor muscle, and sometimes also ligaturing, cutting and removing from the merus the blood

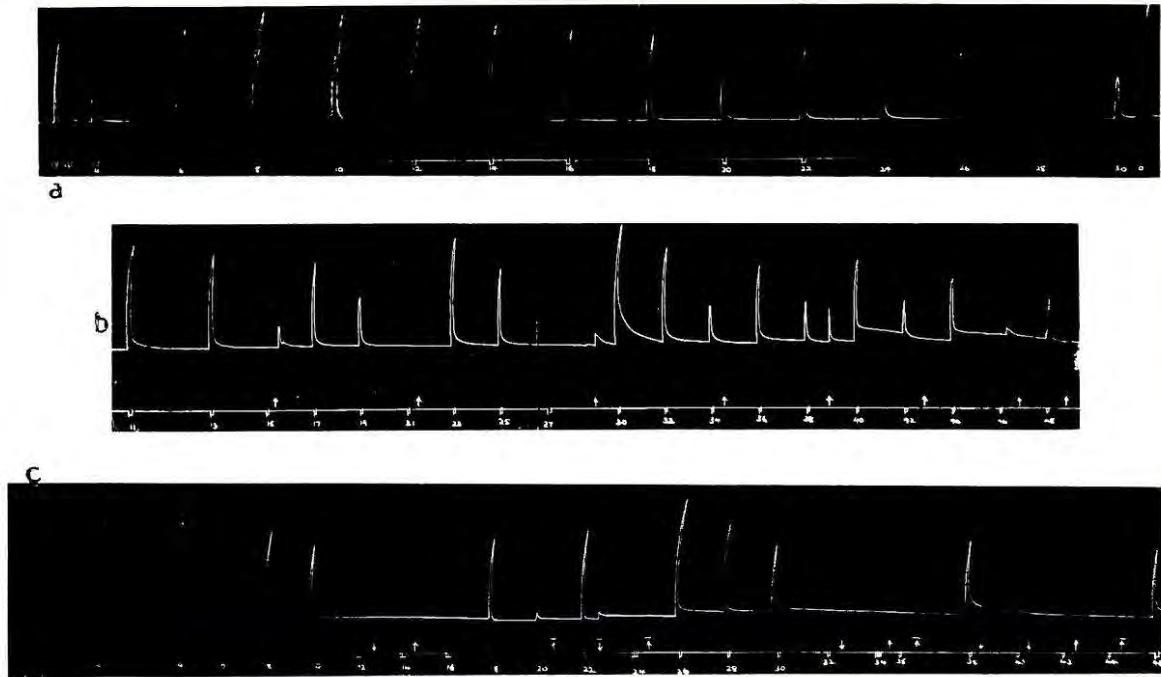

Fig. 15.

Claw opening in response to cathodic stimulation of the isolated opener motor axon, at regular intervals.

The numbers beneath the stimuli represent the time in minutes after commencement of the first stimulus. The stimuli are mostly of 5 seconds duration.

Upward arrows indicate times at which the stimulation electrode was moved distally along the axon, downward arrows proximally. Strokes over the arrows in fig. 15g indicate that the electrode was moved more distally or proximally than previously.

Stimuli : a 7.0 volts, 100 c.p.s., 2.5 msec.

b 2.5 volts, 80 c.p.s., 1.5 msec.

c 1.5 volts, 80 c.p.s., 1.5 msec.

In a the stimulus almost certainly acted at the surface of the saline on the motor axon, since there was no rapid fatigue of the motor axon at the point of stimulation as in b and c, and since the electrode was close to the saline surface.

vessel, and sometimes removing the extensor muscle as well, then separating the three opener-strecher axons, sometimes took from  $\frac{1}{2}$  to  $1\frac{1}{2}$  hours, though the actual time involved in dissecting was of course not as long as the overall time for the complete process. But since the opener muscle frequently did not contract during dissection when this was done carefully, it is highly improbable that fatigue of the opener muscle itself was responsible for the disappearance of the opener reflex. Furthermore, it was frequently noticed that, whereas the opening reflex was quite strong just before separating the opener-strecher axons, after separation it was completely or almost completely absent, so that fatigue of the opener excitor axon as a cause of the disappearance of the opening reflex was improbable. Nevertheless the possibility of motor fatigue remained. Clearly the only way of circumventing this difficulty was to wait until the preparation had recovered from this fatigue. And in fact, as has been mentioned, the preparations sometimes did recover, 1 - 4 hours after isolation of the opener axons, from whatever was abolishing the opening reflex.

2. The second possible cause suggested was that antidromic impulses initiated in the effector axons during the dissection process might have been exerting a depressive effect on the "central excitatory state" of the animal. In vertebrates, antidromic impulses experimentally set up in the motor nerve fibres have such an effect on the C.E.S. (Creed, Eccles, Denny-Brown, et al. 1938), and it is possible that a similar effect was being produced in the crabs by incidental stimulation

of the effector axons during the dissection process, in particular the process of separation of <sup>the</sup> three opener-strecher axons.

In order to try and eliminate this possibility, four animals were cooled at 10°C, two others at 0°C, and one at -10°C, for 1 - 1½ hours each, immediately before dissecting the meri; two of the 10°C animals were cooled again immediately before separating the opener-strecher axons. The perfusion saline was cooled with the crab, so that it remained at approximately the same temperature as the crab throughout the experiment. The experiment was done at room temperature as usual, namely 18 - 23°C. The crabs cooled at -10°C and 0°C remained almost motionless after cooling, and all reflexes remained very weak, too weak, in fact, for experiments on reflex claw opening. The -10°C crab autotomized all its walking legs 3 - 4 hours after cooling, and died 6 hours after cooling. The 0°C animals died 7 and 8 hours, respectively, after cooling. The 10°C animals survived and gave promising results, which are presently to be described. These four experiments, in which the animals were cooled to 10°C, will for the present discussion be referred to as experiments 1 - 4.

In experiment 1, the opening reflex of each cheliped disappeared almost completely after removal of its flexor muscle, but gradually returned after separation of the opener-strecher effector axons. That is, the opening reflex reappeared somewhat more rapidly than in most experiments in which it disappeared. In experiment 2, neither left nor right claw opening reflexes reappeared at all after cooling. In experiment 3, in which the regenerated right cheliped opener-strecher

axons were torn out during removal of the flexor muscle, the left cheliped opening reflex never disappeared or decreased at all during dissection and axon separation. In experiment 4, the right cheliped opening reflex disappeared after removing the flexor muscle, but reappeared again before separating the opener-strecher axons, and did not disappear again; the left cheliped opening reflex decreased in strength slightly on flexor removal, but remained at about half strength throughout the experiment.

It appears, therefore, that cooling of the crab before dissection of the cheliped nerve, and again before separation of the opener-strecher effector axons, does help to prevent the disappearance of the claw opening reflex. However, in experiments 3 and 4, a sharp, two-edged, semi-flattened dissecting needle was used in separating the effector axons. This needle was also used in subsequent experiments, records of ~~two~~ of which are shown in figs. 22, 23. In each of these ~~two~~ experiments, special care was taken in the dissection and axon separation processes, and although the claw opening reflex in each of these experiments did decrease in strength slightly during axon separation, it returned to full strength again afterwards.

From these observations it appears that there may be antidromic impulses initiated in the effector axons by the dissection process which have a depressive effect on the central excitatory state of the animal, or at least of the claw opening reflex. On the other hand, the decrease in the strength of the opening reflex could as well be a result of fatigue of the opener axon - muscle motor system, as indicated

in 1 above. At any rate, cooling the animal before dissection and effector axon separation, <sup>and</sup> using the sharp two-edged flattened dissecting needle for separating the individual opener-strecher axons, both help in minimising the decrease in strength of the claw opening reflex response.

3. The third possible cause, namely cerebral inhibition, was suggested by the fact that in some Insecta the supra-oesophageal ganglion exerts an inhibitory influence on the thoracic ganglia, indicated, inter alia, by the excessive locomotory movements of the thoracic legs after decerebration or elimination of the supra-oesophageal ganglion (Roeder, 1953; et al). It was possible that the same thing was occurring in the crab. Attempts were therefore made to eliminate the cerebral ganglion, both by obliterating the ganglion itself and by cutting the circum-oesophageal connectives. However both these methods proved more difficult than was expected. Owing to the hardness of the exoskeleton and rostral prominence, and to the resilient nature of the cerebral ganglion and circum-oesophageal commissures, it was not possible by merely drilling through the exoskeleton just ventral to the rostral prominence and immediately over the cerebral ganglion, to obliterate the ganglion. It was possible however, to pierce the soft integument at a point just anterior to the mouth opening and immediately posterior to the border of the hard integument in that region. Almost immediately beneath this soft portion lie the two circum-oesophageal commissures, and with a little practice these could be transected with a sharp pair of fine scissors. This was successfully done in two crabs, and

one commissure was successfully cut in another two crabs. However all these crabs died within two or three hours after the operation, although post mortem dissections indicated no greater injury, apart from the transections, than a large congealed mass of blood in the region of the operation. It was unexpected that this should cause <sup>such</sup> a rapid death of the animals. Attempts to avoid this excessive internal haemorrhage failed. Attempts to cauterise the circum-oesophageal commissures in the same spot with a red hot dissecting needle were partially successful. Towards the end of the experimental work an electric cautery instrument was obtained, and the initial attempts to sever the commissures with this instrument were partly successful; moreover the animals survived the operation quite successfully, at least for twelve hours. It is probable that this method, with further practice, would be successful. The few results obtained with the method indicated that transecting the circum-oesophageal connectives **probably would not** solve the problem arising from the apparent central inhibition. The results of these experiments will be described later in section 7.2.

#### 4.6 EXPERIMENTAL PROCEDURE AFTER SEPARATION OF THE EFFECTOR AXONS.

If, after exposure and separation of the opener effector axons, one or both chelipeds responded normally to sensory stimulation by reflex opening, then the experiment could be continued. In experiments involving transection of either the opener motor or the opener inhibitor axons, these axons had first to be identified from

amongst the three effector axons of the opener-strecher axon bundle. To do this it was usually necessary to stimulate one and sometimes two of the three axons, since it was not, except in the later stages of the work, possible to identify them in any other way. The stimulation of the single axons was done in the same way as described in section 3.41.

It was frequently found that, once the opener motor axon had been raised out of the fluid in the merus in preparation for stimulation, or, if not at this stage, then after stimulation of the axon, no further reflex excitation of the opener muscle was possible. This loss of the reflex claw opening response was subsequently shown to be due to injury to the opener motor axon in lifting it out of the fluid or in stimulating it. This was shown in the following manner.

First a reflex opening response was evoked by titillation of the tail. Then the opener motor axon was stimulated at a certain point in the merus, evoking a muscle response. The reflex response was then tested and found to be absent. The opener motor axon was again stimulated, but more proximally on the axon than previously; this time no opening response was obtained to the direct stimulation of the axon. But on a third stimulation of the motor axon, this time more distally than in the first motor axon stimulation, an opening response was evoked similar to the first response to motor axon stimulation. Unfortunately, no kymographic record was made of this experiment. However, the response obtained in another experiment (fig 15c) in which the opener motor axon was stimulated in the

nerus at various points, lead to the same conclusion (15c). When the axon was stimulated more distally than any previous stimulation, a normal large opening response was evoked. When, however it was stimulated more proximally than the most distal previous stimulation, no response was obtained. The response to stimulus 18 was due to the amplitude of stimulus.

Since electrode manipulation of the opener motor axon had this effect of blocking conduction through the point of contact of the axon with the electrode, it was highly probable that a similar blocking effect in the opener inhibitor axon would result from electrode manipulation of this axon. It was therefore decided that, with each crab the particular experiment to be performed would be one involving transection of the one, or sometimes necessarily two, axons which, in the process of identifying the opener motor and specific inhibitor axons, happened to be chosen for stimulation from amongst the three axons of the opener-strecher axon bundle. Thus if, for example, the opener motor axon happened to be chosen first and stimulated, the experiment performed on this crab would be one involving transection of the opener motor axon, namely one to test whether a contraction of the opener muscle could be reflexly inhibited by way of the opener inhibitor axon.

However, at a later stage of the work when more experience had been obtained, it was often possible to identify the opener motor axon without stimulating it and without affecting its through-

conducting ability : usually it was very slightly thicker than the other two axons of the bundle, and sometimes, by just pulling on it slightly with a hooked dissecting needle, a slight opening response could be observed. Once the opener motor and/or specific inhibitor axon had been identified, the main part of the experiment, on reflex claw opening, could be commenced.

In the experiments in which recordings were made of reflex opening in a cheliped with one or more effector axons transected, it was necessary to have recordings from an intact cheliped as a control. Consequently, the procedure was, in general, to record reflex opening of both chelipeds before transecting any axons. Then the relevant axon(s) were transected in one cheliped, while the opposite cheliped was kept intact as a control for simultaneous recording of reflex opening with the operated cheliped. Then the second cheliped was in turn experimented upon. Sometimes, of course, when only one (normal) cheliped was present, only the first of these two controls was available.

5.0 PRELIMINARY REPETITION OF HOFFMANN'S EXPERIMENTS  
USING MECHANICAL SENSORY STIMULATION

5.1 INTRODUCTION.

Working on the European fresh-water crayfish, Astacus fluviatilis, Hoffmann (1914) found that reflex opening of the claws could be very easily evoked by pinching the tail ("schwanz", presumably the uropods and telson), or by lightly tapping it with the finger. If the stimulus was continued for a short while, the opener contraction of an intact claw relaxed after a few seconds. If a stimulus of short duration was repeated at regular intervals, the claw opened in response to each of the first few stimuli but with decreasing amplitudes, and soon ceased to respond altogether. If however, the opener inhibitory axon of one claw was transected, this claw continued to open to the same extent in response to each repeated stimulus, or throughout the whole of a single stimulus of some seconds duration, while the opposite and intact claw responded normally. If the opener inhibitor axon of the intact claw was then transected, this claw responded in the same way as the other claw. The reflex contraction in each claw continued for the duration of the single long stimulus or of repetitive short stimuli until the crayfish fatigued. Reflex contraction could then again be evoked by stimulating the animal in a different place, for instance on a walking leg or on a mandible. Fig. 16 shows the only two records which Hoffmann published to illustrate these results. From these results he concluded that the adaptation of the

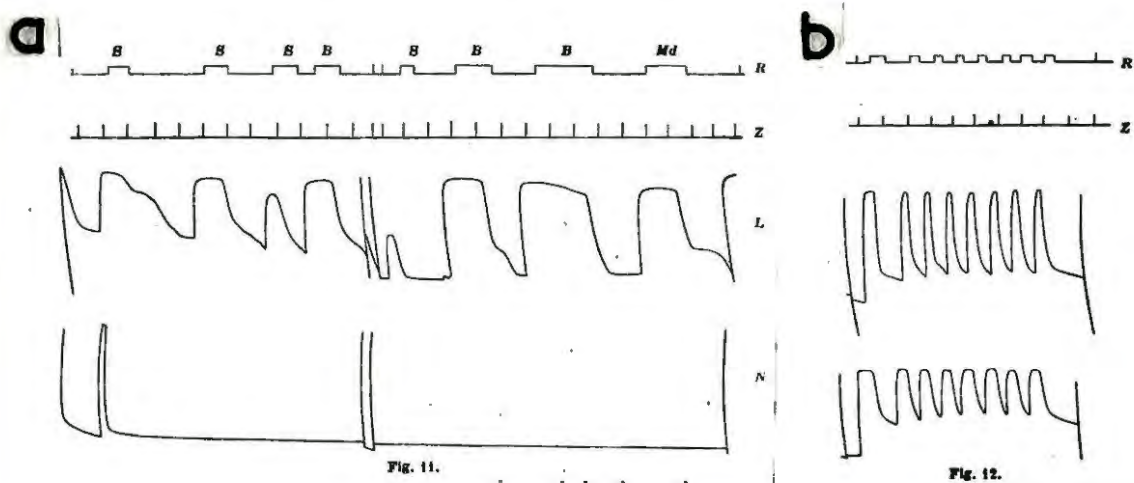

Fig. 16.

Reproduction of two records of Hoffmann (1914), showing reflex opening of both claws in response to repeated mechanical sensory stimulation, in Astacus fluviatilis Linn.

- a opener inhibitor axon intact in right claw (N), transected in left (L)
- b opener inhibitor axon transected in both claws

Stimulus (R) : a pinching with forceps : S tail  
 .B walking leg  
 Md Mandible

b tapping the tail  
 Time (Z) : 10 seconds.

claw opening reflex in intact claws <sup>was</sup> brought about by opener inhibitor axon activity resulting from sensory stimulation to the tail or other part of the body. Clearly the adaptation of the opening reflex was in fact a true adaptation and not merely fatigue of any portion of the reflex system involved.

In attempting to repeat these experiments on Potamon perlatus, there were a number of difficulties which did not exist in the experiments on Astacus. Firstly, reflex claw opening was not always easily evoked by gentle mechanical stimulation of the abdomen, and was less easily evoked by mechanical stimulation on any other region of the body. Secondly, (see fig. 12), the nerve fibres in the cheliped are not separated into two distinct nerve divisions as in Astacus, in which one division (the "thin nerve") contained the opener motor axon (and the closer inhibitor) and the other division the opener inhibitor axon (and the closer motors). The opener motor axon and the specific opener inhibitor axon are both in a single small nerve bundle which contains only one other axon, so that before either the opener inhibitor or the opener excitor could be transected this nerve bundle had to be divided into its component axons, a process which often resulted in blocking of excitatory through-conduction to the muscle, as already described in section 4.6. And thirdly, there was, in addition to the opener specific inhibitor axon, the common inhibitor axon. This axon is very delicate and therefore difficult to manipulate, so that it was usually necessary to transect the whole nerve except the opener axons if it was desired to transect the common inhibitor.

Clearly the first thing to be done in repeating Hoffmann's experiments on Potamon was to show that the reflex claw opening response in the intact animal does in fact show a definite adaptation to long duration or repeated sensory stimuli, as found by Hoffmann. Once this had been done it was desirable to show that the "adaptation" was, in fact, a true adaptation and not merely fatigue within the reflex system involved. However, if it were found that transection of the opener inhibitor axons abolished the adaptation, this in itself would constitute proof that the effect was a true adaptation.

For a full solution of the problem, the following categories of experiments were required.

1. Opener effector axons all intact.
2. Opener specific inhibitor cut.
3. Common inhibitor cut.
4. Specific opener inhibitor and common inhibitor both cut.
5. Opener motor axon cut, and stimulated peripherally.
6. Common inhibitor cut, and opener motor cut and stimulated peripherally.
7. Specific opener inhibitor cut, and opener motor cut and stimulated peripherally.
8. Both inhibitors cut, and opener motor cut and stimulated peripherally.

The category 1 experiments were the initial control <sup>experiments</sup> to demonstrate the presence of adaptation of reflex claw opening. Categories 2 and 5 are the two groups of experiments corresponding to those of Hoffmann on Astacus. The remaining five categories of experiments were necessitated

by the presence of the "common inhibitor" axon in Potamon. In the present work, no experiments in categories 6, 7, and 8 were made. However, the results obtained from experiments in the other five categories indicated that categories 6, 7 and 8 were redundant.

In section 5 only responses to mechanical sensory stimulation will be dealt with. The responses to electrical sensory stimulation will be considered in a later section (section 6), as complicating factors are introduced with electrical stimulation. Adaptation to long duration sensory stimuli of 10 seconds or more has not been extensively studied, and will be considered in section 5.2. Adaptation to repeated sensory stimuli will be dealt with in sections 5.3 - 5.8, and in section 5.9, experiments on reflex inhibition involving transection of the opener exciter axon will be considered.

FOOTNOTE : Except where otherwise indicated, the word "adaptation" will here be used to denote the effect constituting a decrease in the height of the recorded response with long duration or repeated stimuli, whether this effect be a true adaptation or partly or wholly a fatigue effect.

## 5.2 ADAPTATION TO LONG-DURATION MECHANICAL SENSORY STIMULI, WITH ALL MOTOR AXONS INTACT.

A few exploratory experiments were made at an early stage of this work to test the adaptation of the reflex claw-opening response to long duration stimuli of 15 seconds or more. At this stage, the light recording lever springs which had been used in the axon innervation investigation experiments were still in use.

Frequently, in response to a long duration sensory stimulus in these experiments, a tonic contraction of the opener developed which was maintained for a considerable time after cessation of the stimulus... fig. 17 (a). Sometimes the tension continued to rise after cessation of the stimulus (b); sometimes it decreased slowly during and after the stimulus (c); sometimes it decreased abruptly during the stimulus (C and D) and rose again if the stimulus intensity and/or frequency was increased (d); occasionally it rose slightly abruptly after cessation of the stimulus (e). In subsequent experiments in which mechanical sensory stimuli of 10 to 15 seconds duration were applied, decreasing tension of the opener muscle was occasionally maintained for 5 to 15 seconds after cessation of the stimulus and then suddenly relaxed, whereas after short stimuli of 2 to 5 seconds duration tension was not maintained after cessation of stimulation, e.g. fig. 26(a). Since the cerebral ganglion was not eliminated in any of these experiments it is possible that cerebral nervous influence was responsible for some of the variability.

In any case, largely because of the apparent absence of any definite and consistent form of adaptation to long-duration sensory stimuli, either mechanical or electrical, further experiments of this type <sup>of</sup> sensory stimuli were not made. Nevertheless, there are indications that a more extensive study of adaptation to long stimuli would be of value. For instance the redevelopment of opener tension shown in fig. 17(d) at x and y in response to increased stimulation frequency suggests that the previous abrupt relaxation of the opener during the same sensory stimulus was in fact a true adaptation of some form to the

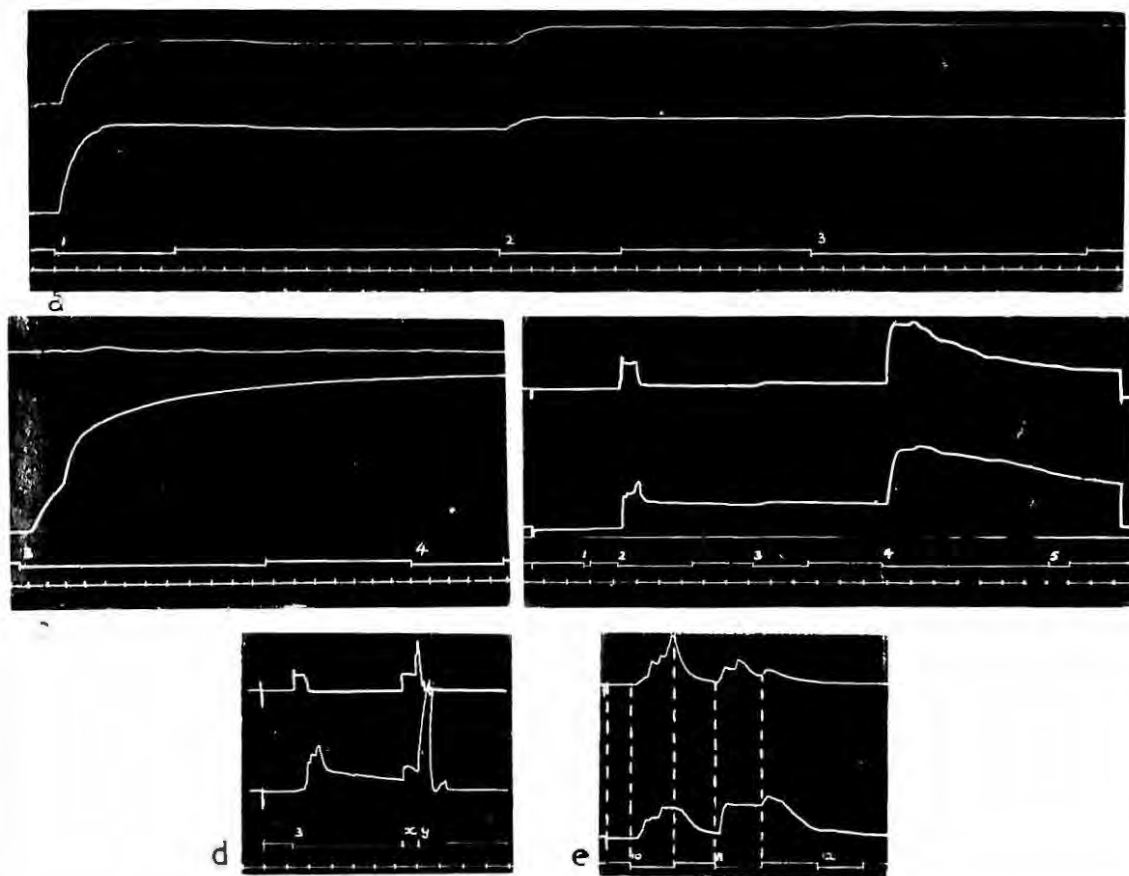

Fig. 17.

Reflex opening of both claws in *Petalonia peltatus* in response to long-duration mechanical sensory stimuli on the outside surface of the last segment of the abdomen while it was held open by a wire loop.

Upper traces : left claw  
Lower traces : right claw

a, b crab 1

c, d crab 2

e crab 3

Closer tendons intact in a, c, d; transected in b, e.

Opener axons intact in a-d and in right in e; opener inhibitor transected in left in e.

NOTE : In all kymographic records in this work with responses of both claws :  
UPPER TRACES : LEFT CLAW ; LOWER TRACES : RIGHT CLAW.

sensory stimulus.

As mentioned in the next section (5.2) on adaptation to repeated stimuli, there was occasionally a sudden relaxation of opener tension during one or more of the individual sensory stimuli, that is before cessation of the stimulus. This again, could conceivably have been adaptation as a result of reflex inhibition. In one instance (see section 5.3, and fig. 19(a) ) such an effect did in fact occur in the intact claw but not in the other claw in which the specific opener inhibitor had been transected; this supports the idea of its being due to reflex inhibition. In other instances, it did occur more frequently in intact-axon claws than in inhibitory-less claws, but its occurrence was not consistent in similar conditions and was in fact rather erratic therefore, it is not possible to draw any definite conclusions from it, further than that the phenomenon is suggestive of reflex inhibition via the inhibitor axons, and therefore deserves attention in further experiments.

Clearly adaptation of the cheliped opening reflex in response to long-duration mechanical sensory stimuli should be investigated further.

### 5.3 ADAPTATION TO REPEATED MECHANICAL SENSORY STIMULI WITH ALL MOTOR AXONS INTACT.

A number of experiments were made in which all the opener axons in the cheliped were left intact. In some the nervus was left intact, in others it was dissected in the usual way and the flexor

muscle removed. In some the opener-strecher bundle axons were separated but left intact. In most of the experiments the closer muscle tendons were cut through at their articulations with dactyli, in order to avoid any complication arising from the intact closer muscles.

In each of these experiments a particular form and duration of sensory stimulus was repeated at regular intervals to determine the adaptation of the reflex claw opening responses to the sensory stimuli. This was done in different experiments using the different forms of mechanical sensory stimulus described in section 4.31, with stimuli of different intensities, durations and repetition intervals. Although the titillator hammer stimulus on the tip of the opened abdomen was the most suitable and reliable form of stimulus, this would not always evoke reflex opening so that it was sometimes necessary to use other forms.

Most of the recordings made in these experiments show clear-cut adaptation of the response/repeated stimuli (fig. 18). The rate of adaptation increased or decreased with increasing or decreasing (respectively) duration and frequency of repetition of the stimulus. This was not unexpected whatever the nature of the adaptation.

Most frequently the adaptation was revealed only in a decrease, with repeated stimuli, in the tension developed by the muscle as reflected in the recording lever displacement. Sometimes however it also showed up in a decrease, with repeated stimuli, in the duration for which the response tension was maintained. Not infrequently responses were obtained to only the first one or two stimuli, as Hoffmann

Fig. 18.

Reflex claw opening in response to repeated mechanical sensory stimuli on the outside surface of the last abdominal segment.

Closer tendons of both claws cut.

Opener axons of both claws intact.

Stimuli : heavy titillator, with plasticene hammer.

Time : 5 seconds.

Fig. 19.

Reflex claw opening in response to repeated mechanical sensory stimuli on the outside surface of the last abdominal segment.

Closer tendons of both claws cut.

Specific opener inhibitor axon transected in left claw, intact in right.

Stimuli : heavy titillator, with plasticene hammer.

Time : 5 seconds.

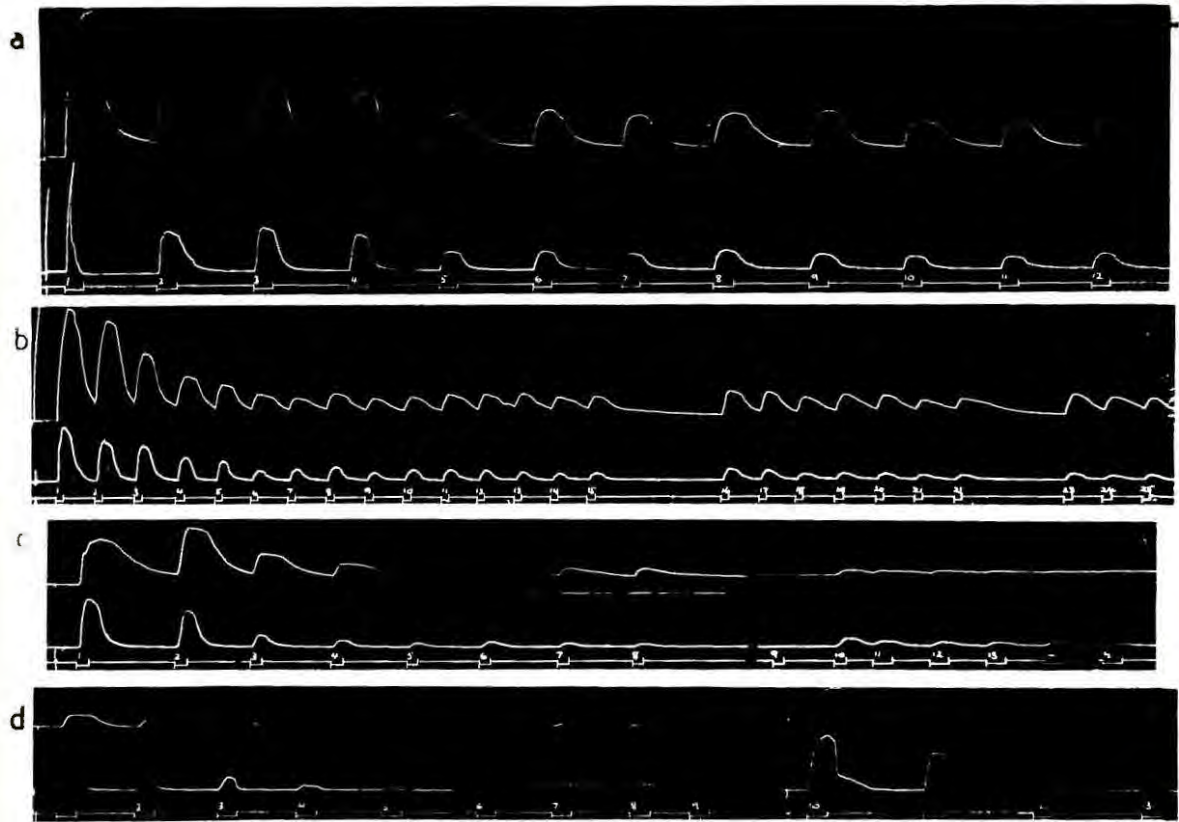
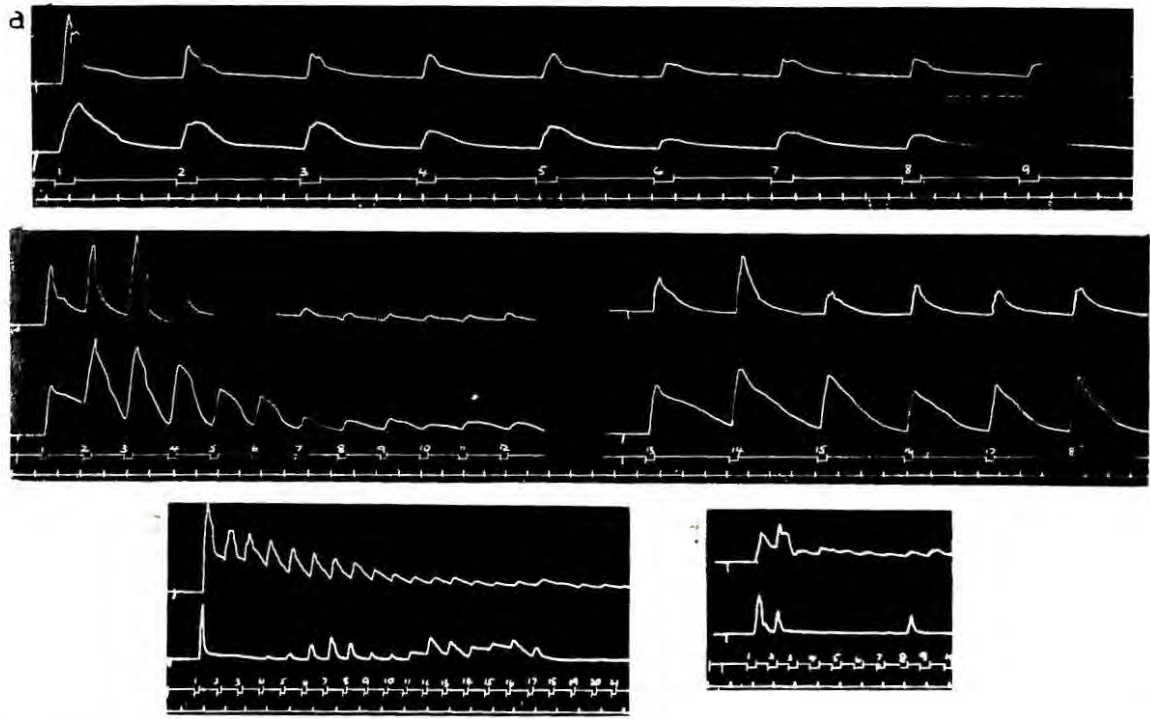

sometimes found. Clearly the form of the recorded responses depended to a certain extent upon the characteristics of the recording lever set-up, so that a certain amount of variability was introduced by this factor.

#### 5.4 ADAPTATION WITH OPENER SPECIFIC INHIBITOR CUT.

In these experiments the opener specific inhibitor was transected in the manus as described in section 4.6. This was usually done in one claw at a time, keeping the other claw with its axons all intact as a control. A record of the response of the claw whose opener inhibitor axon was to be cut was usually made before cutting the axon, this serving as a further control.

In none of these experiments was there found any significant or consistent difference in behaviour of the intact-axon control claw and the claw with the opener inhibitor transected. Similar degrees and rates of adaptation were apparent in the control and experimental claws of any one animal. This applied equally with different sensory stimulus repetition frequencies.

Fig. 19 shows a fairly typical example of "adaptation" at different repetition frequencies, with the opener specific inhibitor cut in the left claw (upper trace) compared with the adaptation in the right claw (lower trace) with axons intact. There was no apparent change in the responses of the left claw when the opener inhibitor was cut, and clearly there is little significant difference between the responses of the left claw after section of the opener inhibitor and that

of the control right claw with the opener axons all intact. The only difference of note in this experiment, one which was, however, not typical of other experiments, was in the response to the first stimulus in (a). The contraction tension in the right claw fell immediately after reaching a maximum, and was not held for the duration of the stimulus as in the left claw, and as in all subsequent responses of both claws. This relaxation of tension in the right claw could conceivably have been adaptation as a result of simple reflex inhibition via the opener inhibitor axon <sup>which</sup> could not occur in the left claw since the opener inhibitor was cut. However, since there were no similar effects in subsequent responses of the right claw, it seems more likely to have been a result of central nervous influence. This will be discussed later.

#### 5.5 ADAPTATION WITH THE COMMON INHIBITOR CUT.

Two experiments were made in which the common inhibitor axon was cut but the specific opener inhibitor was not. This was done by transecting the whole of the nerve in the merus except the three opener-strecher effector axons. Again, and in both these experiments, no difference was found between the opening response to repeated sensory stimuli before nerve transection and that after nerve transection, nor between the response of the one control claw in which no axons were cut and that of the other claw in which the common inhibitor had been cut.

In four further experiments, in which both the specific opener inhibitor and the common inhibitor were cut by transecting the whole nerve in the merus except the opener motor axon, the same result was ob-

-tained. Again there was no difference in any one crab between the control claw and the experimental claw.

#### 5.6 POSSIBLE CAUSES OF THE REFLEX ADAPTATION.

NOTE : The term "reflex adaptation" in this and subsequent sections is equivalent in meaning to the term "adaptation" as defined in section 5.1 and used in sections 5.2 - 5.4, that is, it means the decrease, with repeated sensory stimuli in the amplitude of the mechanical responses of reflex claw opening.

Four alternative causes of the adaptation of the claw opening reflex to repeated sensory stimuli are possible : (1) inhibitor adaptation; (2) motor fatigue; (3) sensory adaptation; and (4) central adaptation.

The term inhibitor adaptation implies adaptation effected by increasing opener inhibitor and/or common inhibitor axon discharge resulting from the continued sensory stimuli; this is basically, what Hoffmann (1914) concluded was the cause of the adaptation of reflex claw opening in Astacus . The term motor fatigue implies, primarily, fatigue of the opener muscle due to excessive prolonged or repeated contraction; it also included - for the sake of comprehensiveness, though it is unlikely that this should occur - fatigue at the opener motor axon neuromuscular junction, that is, progressive blocking of the NMJ due to excessive NMJ transmission. The term sensory adaptation implies a decrease in the responsiveness of the sensory receptors to sensory stimulation, whether there be a true adaptation of the sensory receptors, or an apparent adaptation or "sensory fatigue" due to temporary injury to the sensory receptors by excessively heavy stimulation; for present purposes

there is no point in distinguishing between these two forms of sensory adaptation. The term central adaptation implies any adaptation effected within the central nervous system of the animal (excluding inhibitor adaptation); it therefore includes adaptation at the central synapse of the opener motor axon, that is, decrease in the rate of transmission across this synapse.

#### 5.61 Inhibitor adaptation.

The observations made in sections 5.2 - 5.4 indicate that inhibitor adaptation is not responsible for the adaptation of the claw opening reflex to the forms of repeated sensory stimulation which were used in the experiments described in these sections. This clearly follows from the fact that transection of the specific opener inhibitor and/or the common inhibitor axons has no apparent effect on the reflex adaptation. However, this does not eliminate the possibility that such motor adaptation does occur on prolonged or repeated sensory stimulation, and that it does help to effect the reflex adaptation.

Firstly, for instance, if the reflex adaptation were due simply to motor fatigue, then this fatigue might obscure any effects of motor adaptation which might, nevertheless, also be a causative factor in the reflex adaptation. Secondly, if sensory adaptation were effecting the reflex adaptations so far described then either the sensory adaptation might obscure the effects of motor adaptation or there might be no simultaneous motor adaptation because the decrease, with repeated sensory stimuli in the afferent discharge might be sufficiently great to prevent the possibility of motor adaptation occurring. On the other hand, if

central adaptation is responsible for the reflex adaptation, then it is improbable that inhibitor adaptation also plays a role in effecting the reflex adaptation; since it would be biologically uneconomical to have two distinct mechanisms, namely central and inhibitor adaptation; for effecting the reflex adaptation.

Clearly, in order to determine whether, in fact, inhibitor adaptation does occur at all in reflex claw opening adaptation, the other three possible causes of the reflex adaptation must first be considered, and if possible, eliminated experimentally.

#### 5.62 Motor fatigue.

A number of experimental attempts were made to test whether there was any motor fatigue of the opener myoneural system at the frequencies and durations of the sensory stimuli used. Direct stimuli to the opener motor axon were interposed between the sensory stimuli, at the same repetition frequency and with the same stimulus duration as the sensory stimuli. These direct axonal stimuli were applied with small platinum hook electrodes as described in section 3.41, using the micromanipulator electrode holder described in section 2.43(4), and a flexible wire electrode as described in 2.43(1) for the other electrode. The polarity of the electrodes was reversible. Square-wave stimuli of approximately 0.1 volts 60 c.p.s. and 1.5 msec. pulse duration, were used, so as to evoke opener responses of about the same magnitude as those evoked by the sensory stimuli.

However this method was unsuccessful. This was because

manipulation and stimulation of the opener excitor axon in the electrode injured the axon just sufficiently to block the through-conduction path of the reflex arc. This effect was described in section 4.5. The use of a layer of paraffin on top of the saline in the merus was not effective in preventing this slight injury to the axon. The platinum wire hook of the electrode used was of circular cross-section, as usual. The use of an electrode with a hook of semi-flattened cross-section bent for the axon to rest on the flattened inside face of the hook would have increased the chances of this method being successful, but unfortunately lack of time prevented this method being tried. A variation of the above method, which was, however, not tried was to stimulate the motor axon after a series of sensory stimuli with the same stimulus repetition frequency and duration of stimulus as the sensory stimuli. In this way it would be possible to compare the two rates of "adaptation" and see whether they were the same, in which case motor fatigue would be indicated.

To solve this problem of whether motor fatigue was affecting the results it therefore became necessary to resort to indirect evidence from other experiments.

During some of the experiments on the investigation of the axonal innervation of the cheliped opener muscle, the opener motor axon was stimulated in the merus at 0.1 volts, 45 c.p.s. and 1.5 msec. pulse duration for periods of  $1\frac{1}{2}$  minutes. During these periods there was no indication of any fatigue of the opener motor system at maximal or sub-maximal opening of the claw. However, the springs used in these experiments were weak compared to those used in the reflex claw opener

experiments, so that the results are not really comparable.

In an experiment using a starter lever spring the whole nerve of an isolated limb was stimulated in the merus for 100 seconds continuously at 1.5 volts, 40 c.p.s., and 1.5 msec., with interspersed 120 c.p.s. bursts bringing the contraction to maximum tension. This record is shown in fig. 20a. Clearly there is no indication of any fatigue of the motor system. In another experiment a cheliped's opener motor axon was stimulated directly for 50 seconds continuously at 0.1 volts, 100 c.p.s. and 1.5 msec., with no sign at all of motor fatigue (fig. 29a). Sensory stimuli applied during the motor axon stimulus had no apparent reflex inhibitory effect. In a similar experiment sensory stimuli applied during a 150 second long stimulus of 0.4 volts, 100 c.p.s., and 1.5 msec., to the opener axon did have slight reflex inhibitory effects on the opener contraction (fig. 29d). During the motor stimulus there was only a gradual decrease in the opener tension, apart from the decrease caused by the sensory stimuli. Clearly this small motor fatigue is not sufficient to account for the reflex claw opening adaptation. In all three experiments quoted here, the amplitude of the mechanical claw opening response was of the order of amplitudes of the initial few reflex claw opening responses in the reflex adaptation experiments. For this reason, and also from mere speculation as to the intensity of excitation of the opener motor axon by sensory stimulation, it is unlikely that greater degrees of excitation are experienced by the opener motor axon on sensory stimulation.

Stronger motor stimulation does, not unexpectedly, cause motor

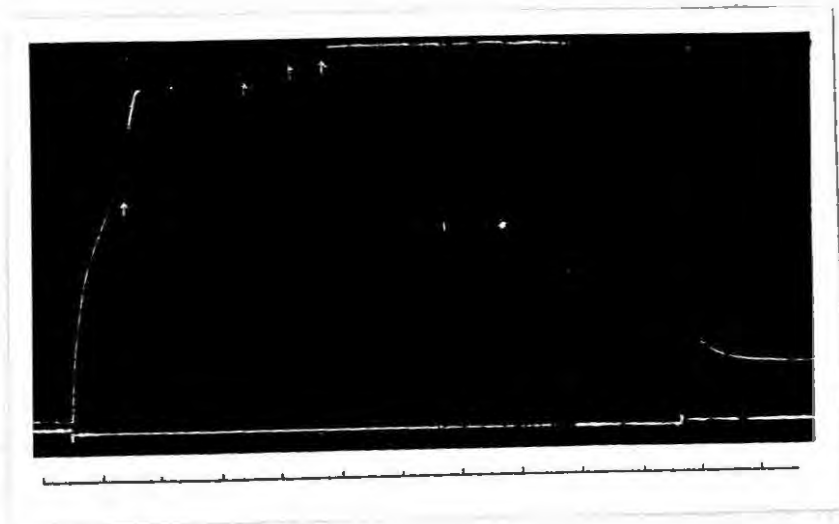

Fig. 20a.

Opening of an isolated claw in response to stimulation of the whole nerve in the merus.

Stimulus : 1.5 volts, 40 c.p.s., 1.5 msec.

Time : 5 seconds.

At each arrow the stimulus frequency was momentarily increased to 120 c.p.s.

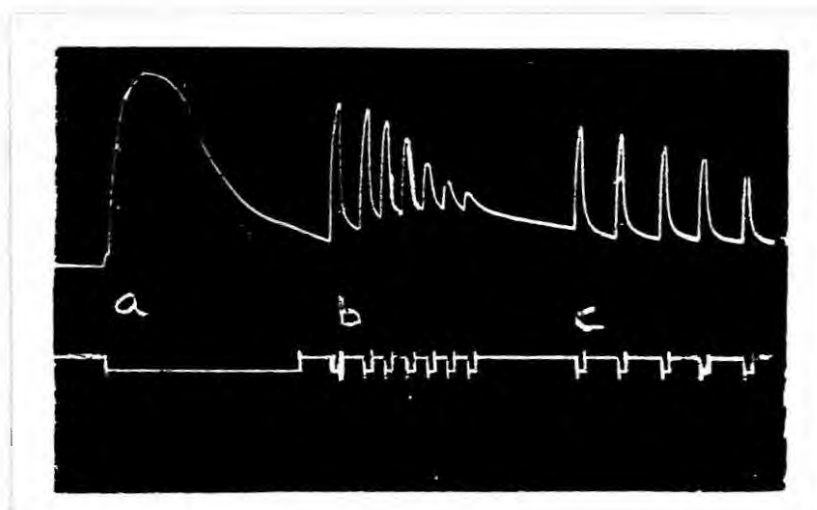

Fig. 20b.

Opening of a claw in response to stimulation of the opener motor axon.

Stimuli : 2.5 volts, 50 c.p.s., 1.5 msec.; anode on axon.

Time : a 2 minutes; b 5 seconds every 15 seconds; c 5 seconds every 30 secs.

fatigue. As already indicated, it is improbable that the excitation of the opener motor axon caused by sensory stimulation is nearly as strong as its excitation by strong stimulation of the motor axon. Nevertheless a comparison of the rates of fatigue of the opener motor system in response to strong repeated motor stimuli, with the rates of reflex claw opening adaptation, is pertinent to this discussion. Evidence on the rates of motor fatigue to direct motor stimulation is available from two sources: (a) the experiment recorded in fig. 21, in which the opener motor axon was stimulated at various repetition frequencies, at 2.5 volts, 50 c.p.s., and 1.5 msec.; and (b) experiments recorded in section 6.3, figs. 35 - 36, where, as explained, general electrical stimulation had a direct and strong stimulatory effect on the cheliped opener motor system. Such a comparison shows that the reflex adaptation over the initial few responses to sensory stimuli, these being the important responses in this respect, is in general faster, relative to the adaptation over the subsequent responses, and more hyperbolic, than the corresponding initial "motor fatigue" resulting from direct motor stimulation at similar stimulus durations and repetition frequencies. This indicates that the two decreasing response effects are not manifestations of the same cause, and therefore that the reflex opening adaptation is not due to motor fatigues.

Thus the evidence all indicates that fatigue of the opener motor system is not responsible for the adaptation of the claw opening reflex to repeated sensory stimulation. There still remains the possibility of its being due to adaptation within the sensory and/or the central elements of the claw opening reflex system.

5.63 Sensory adaptation.

The next thing was to test whether adaptation of the tactile sensory receptors was influencing or determining the adaptation of repeated sensory flex claw opening to stimuli. The best way of doing this would have been to stimulate the animal in two distinct places, stimulation of which produced similar reflex opening responses, for example on the outside of the abdomen and on the sternal plate. If sensory adaptation was a factor causing the adaptation of reflex claw opening, then, when the opening reflex had adapted somewhat to repeated stimulation in the first place a strong reflex opening response would again be evoked by transferring the repeated stimulation to the second place. However, if the adaptation was due not to sensory adaptation but to central adaptation, there would be no increase to former strength of the opening response.

Unfortunately no records of experiments of this form were made, as only a few exploratory experiments of this kind were done. The technical difficulty of moving the titillator from its position for abdominal stimulation and fixing it in a new position for sternal plate stimulation was not overcome in the short time given to such experiments. The few observations made were as a result not consistent, and were somewhat equivocal. However, in a few experiments, in which fairly strong titillator stimulation with the plasticene hammer applied on the outside tip of the abdomen which was held open against the inverted wire loop, evoked strong reflex claw opening which quickly became adapted to the

repeated stimuli, the sternal plate was stroked with a metal rod within 5 - 30 seconds after the last small response to a titillator stimulus; the stroking evoked strong reflex opening again. This clearly suggested adaptation of the sensory receptors in the abdomen as being at least partly the cause of the adaptation.

Certain indirect evidence also suggests sensory adaptation, due possibly to temporary injury to the sensory receptors, <sup>as</sup> the cause of the adaptation of the opening reflex to repeated titillator stimuli with or without the plasticine hammer, and with the abdomen open against the inverted wire loop. Referring back to fig. 19, it can be seen that after the long rest of 25 minutes between records a and b, the first response of record b is not a great deal smaller than the first response in record a. However, the first response after each of the two 30-second rests in record b is not much larger than the response immediately preceding it, which is very small. Had the reflex adaptation been a true central or inhibitor adaptation it seems likely that the first response after each of these two rests would have been considerably larger, though it is possible that a true central or inhibitor adaptation would be maintained for 30 seconds or more. Nevertheless, comparisons, on the same lines, between the first response after the 3-minute rest after stimulus C 8, and the first response after the 50-minute rest between c and d, makes sensory adaptation due to temporary injury of sensory receptors more likely than central or inhibitor adaptation in this case.

Other evidence favouring sensory adaptation rather than

central adaptation is the close similarity between right and left claws in the form of their adaptation to titillator stimuli, whether or not one claw differed from the other in having its opener inhibitors transected. Sensory adaptation is the more probable because with central adaptation there might be expected to be some discriminatory effect on right and left claws..... see figs. 18 (a and b) and 19 (a to d). The similarity between left and right claw responses occurred more commonly with titillator stimulation and wire loop holding open the abdomen than with abdominal electrical or sternal stroking stimulation. This suggests that with the wire loop and titillator stimulus and predominant effect was sensory adaptation owing to the large and widespread pressure on the inside surface of the abdomen by the titillator and wire hoop combination, whereas with the abdominal electrical or sternal stroking sensory stimulation, the predominant effect was central. Nevertheless, that central adaptation does influence the reflex claw opening adaptation is indicated, in fig 18(c and d), by the dissimilarity between left and right claw responses.

#### 5.64 Central Adaptation.

Evidence from other experiments on adaptation of reflex/<sup>claw</sup>opening to medium to heavy repeated titillator stimulation indicates central nervous influence in the adaptation of reflex claw opening. The effects illustrated in the records in fig. 21 were not uncommon in these experiments.

The large post-stimulus "spike" responses in g were undoubtedly effects of central nervous activity, and in all probability resulted from release from **strong** central inhibition of some kind. That there was some

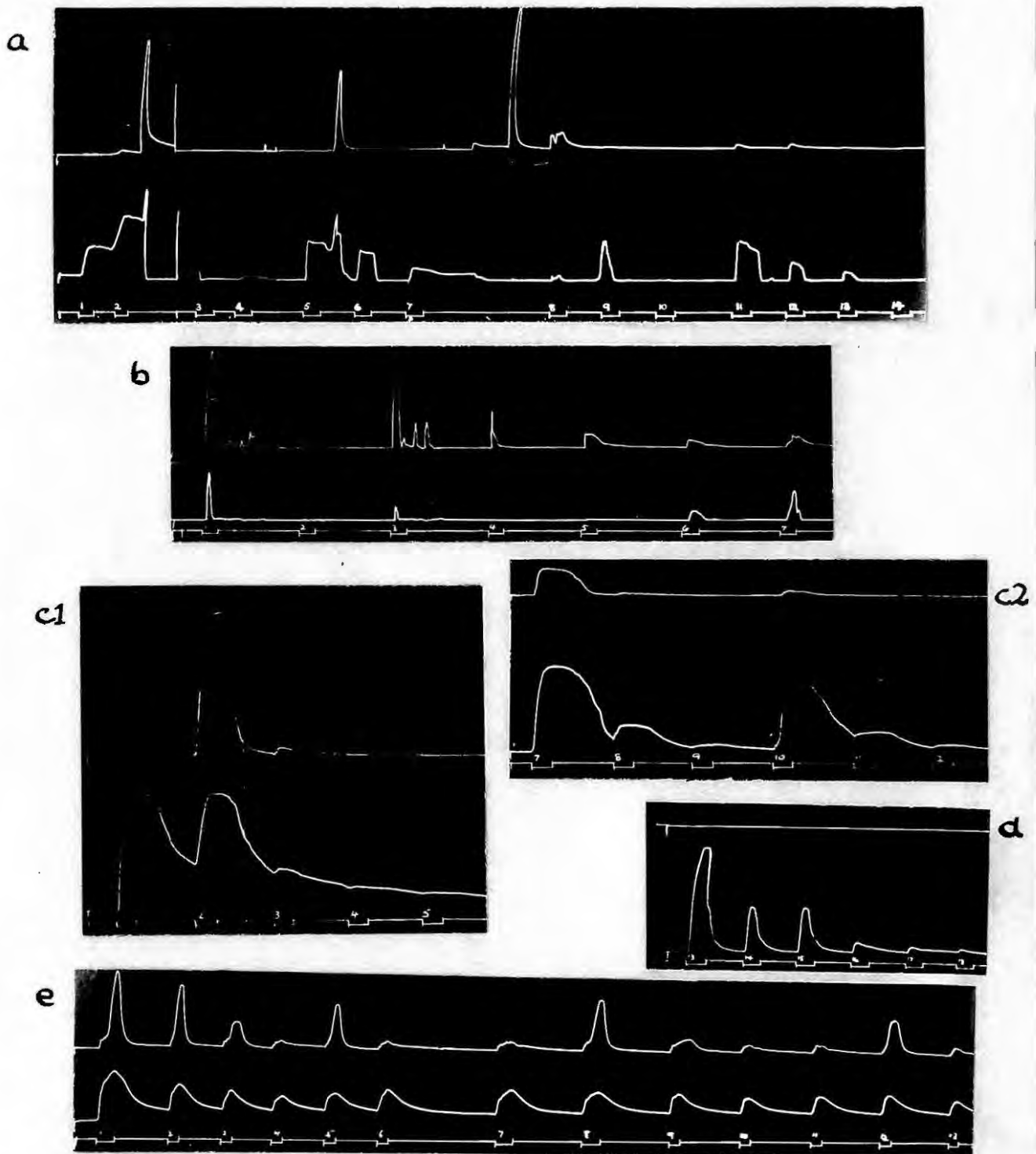

Fig. 21.

Reflex claw opening in response to medium intensity titillator stimulation on the outside surface of the opened abdomen.

a and d : crab 1; b crab 2; c1 and c2 crab 3; e crab 4.

Time : 5-second stimuli; except stimuli 2-5 in e : 3-second stimuli.

kind of central inhibition acting is indicated by the almost complete absence of direct responses of the left claw, in which only the opener axon was intact, to titillator stimuli, although the motor elements of the left claw opening reflex were clearly intact and functioning, as witness the response to stimulus 8. Whether this absence of direct responses by the left claw is in some way an effect of the opener and common inhibitors being transected is doubtful, because of the absence of a control recording, but consideration of other equivalent experiments indicates that this is not the case. A further indication of central influence in a is the suggestion of a build-up of central excitation over responses 1 and 2 in both left and right claws. The clearcut right claw adaptation and less clearcut left claw adaptations of the opening reflex, over responses 5 - 7 8 - 10, and 11 - 14, indicate that the reflex adaptation was not entirely overruled by central activity. Furthermore, the recurrence of clearcut adaptations in the right claw after the relatively long intervals before stimuli 5 and 11 indicate that these reflex adaptations were due to a true adaptation, probably central but certainly not sensory.

The alternate large and small responses (1 and 3) in b indicate central control of the opening reflex adaptation. The erratic responses following each of the direct responses 1 and 3 in the left claw are evidently after-discharge effects resulting from high central excitation. High central excitation resulting from the strong titillator stimulus used was presumably accompanied by high central inhibition, which is indicated by complete absence of opening response to stimulus 2.

Central inhibition was in all probability also the cause of the sudden drop in response strength in c, after response 2 in c1 and after

response 1 in c2, that is both before and after transection of the opener inhibitor axon of the left claw. There was no change in the intensity or frequency of the stimulus at 10, so that recurrence of the reflex adaptation could scarcely have been a result of anything other than release from central inhibition. Of doubtful significance in this record is the observation that, after inhibitor transection only the first response was large, whereas before transection the first two responses were large.

The "Stepwise" reflex adaptation in d is reminiscent of the adaptation in C (1), and has been observed in several other experiments, in particular those with lighter titillator stimulation (see figs. 22 and 24). Fig. 21 d is a recording made from the same crab as g, so that the reflex adaptation was very likely due to central adaptation. This raises the possibility of the central adaptation being determined by central inhibition which is "turned on" in certain fixed "quanta". This could be effected, for instance, by progressive blocking of central synapses in the claw opening reflex arc. However, this is highly speculative and is not pertinent to the present observations.

left and right

The/claws of many animals in the adaptation experiments showed dissimilar reflex adaptation to repeated stimuli, irrespective of whether or not the claws differed in one having its opener inhibitors transected. This effect has already been indicated and is further exemplified in fig. 21(e). Sometimes one or both claws showed unsynchronised recurrent adaptations, each adaptation following a relatively large response. This intermittent appearance of large responses in itself, as well as the fact the adaptations in the two claws were not synchronised, suggests central

rather than sensory adaptation as a causative factor in the reflex adaptation.

Sometimes, as for example, in the experiment recorded in fig. 18 both synchronised reflex adaptations to repeated sensory stimuli and unsynchronised reflex adaptations or other variations in reflex response strength, occur in one preparation: "Synchronisness" and "unsynchronisness" are therefore not peculiarities found separately in different crabs. In the experiment of fig. 18, the adaptations of reflex claw opening were synchronised in a and b, but unsynchronised in c and d. **The left claw adaptation in g resembles** in form reflex adaptations caused by sensory adaptation, as in a and b and in fig. 19 (a - d). On the other hand, the erratic right claw response in g indicates central influence as does the left claw response in d. The central influence in the right claw response in g, and the large right claw response (8) in d to a higher frequency stimulus, compared to the absence of a correspondingly large response in the left claw, indicate that the right claw reflex adaptations following response 1 in c and d, respectively, are not due to sensory but to central or inhibitor adaptations.

Taking into consideration the fact that the titillator frequency was decreased before g and again before d, the following tentative interpretation of the responses of fig. 18 may be put forward. In a and b, high frequency sensory stimulation incurred sensory adaptation to repeated stimuli, and this dominated the response of both claws. The decrease in stimulus frequency before g, and again before d, released first the right claw (in g), and then the left claw (in d), from the dominance of sensory

adaptation, right and left claws being released independently because perhaps, of assymetrical central influence. The emergence, in the right claw, of a clearcut adaptation which was independent of the sensory adaptation resulting from stronger sensory stimuli, suggests that reflex claw opening adapts to right sensory stimuli by central and/or inhibitor adaptation, whereas with heavier sensory stimuli, sensory adaptation obscures any central and/or inhibitory adaptation.

#### 5.65 Conclusion.

From these and other observations made during the course of the titillator experiments it was concluded that sensory adaptation was effective to a large extent, the adaptation of reflex claw opening to strong sensory stimuli, applied with the titillator hammer on the outside surface of the abdomen while this was held open against the wire loop. It was further concluded that central nervous inhibitory influence was affecting the responses. When lighter mechanical sensory stimuli were used, central and/or inhibitor adaptation manifested itself as the causative factors in the reflex adaptation. Thus there were two requirements for further progress: (1) to use lighter mechanical stimuli and thus eliminate sensory adaptation; and (2) to eliminate the cerebral ganglion before experimenting, assuming this to exert an inhibitory influence on the thoracic ganglion. This assumption was made on the grounds that since the cerebral ganglion in insects and in at least some crustaceans has an inhibitory effect on locomotor activity (Bothe 1897; et al), it seemed probable that it would have a similar effect on the cheliped ganglion in crabs. Another reason for eliminating the cerebral ganglion before

experimenting has been described in section 4.5(3). These conclusions were drawn late in the course of the experimental work, so that only a few experiments were made utilising the two changes in experimental procedure.

#### 5.7 ADAPTATION TO LIGHT MECHANICAL SENSORY STIMULI.

The conclusions in the last section were drawn late in the course of the experimental work, so that only a few exploratory experiments were made testing the effects of the two modifications in experimental procedure outlined in the last paragraph. No experiments were completed showing the effects on reflex claw opening of unilateral or bilateral cerebral ganglion elimination. In the second of the five experiments described below, however, transection of the right circumoesophageal commissure had no apparent effect on the recorded adaptation of the opening reflex of the left (contralateral) claw. Further experiments are necessary to test the effect of ipsilateral or bilateral commissure transection.

In the first four of the five experiments described in this section, light mechanical stimulation, with the bare rounded end of the titillator hammer rod, was applied near the tip of the opened abdomen, on its inside surface. In the fifth experiment, a similar stimulus was applied near the tip of the abdomen on its outside surface. The closer muscle tendons of the claws were cut in all except the third experiment, in which they were left intact. Only left claw responses were recorded in both the first and the second experiments, since an injury during dissection, to the abnormally positioned opener motor axon of the

right claw abolished the opening reflex of this claw. A record was obtained of reflex claw opening responses after transection of the specific opener and common inhibitor axons only in one experiment, the first. In the other four experiments, records were made only with all the opener axons intact. Unfortunately, the kymograph records of the left claw responses of the first and second experiments were misplaced, and are therefore not available. However, the following description summarises the relevant points, which were recorded in writing from the kymographic records soon after completion of each experiment. Reference to points of importance in the records of the other experiments then follows.

#### Experiment 1.

A kymograph record was made 1 hour before inhibitor axon transection of reflex opening responses of the left claw to stimuli of 5. The response to the first stimulus was small but there was a rapid and clearcut hyperbolic decrease in response strength over the first three responses to a very small fourth response, followed by no further mechanical responses to subsequent stimuli.  $1\frac{1}{2}$  hours after transection of the specific opener and common inhibitor axons, the animal was again stimulated as before, but for 10 seconds every 30 seconds for 3 minutes. The 10 second stimulus duration was necessary to evoke a reasonable sized response. The response thus evoked by the first stimulus was still slightly smaller than the first response in the first record. Again there was a rapid and clearcut hyperbolic adaptation similar to that in the record before inhibitor transection, culminating in zero recorded response to stimulus 4. For two or three seconds during each of stimuli 5, 6, and 7, a temporary increase in titillator frequency caused a temporary

development of recorded tension slightly less than that of the first response. This showed that the adaptation after inhibitor transection was in fact a true adaptation and not merely fatigue. Further recording of the left claw opening reflex was not possible because the opening reflex gradually became dormant and unevokable.

It may be concluded that in this one experiment the adaptation of the left claw opening reflex to repeated titillator stimuli was not effected through neuro-muscular-functional inhibition by the specific opener or common inhibitor axon. Attempts to repeat this experiment and test this conclusion were unsuccessful. In each of the other three experiments the claw opening reflex in response to light abdominal titillator stimulation became dormant after the first one or two records with opener axons intact.

#### Experiment 2

In this experiment the tail was stimulated for 5 seconds every 30 seconds for 3 minutes. The first stimulus evoked a large reflex claw opening response, the second a very small response, and the ensuing stimuli evoked no response at all. The inhibitor axons were not cut.

The following observations and tentative deductions from the kymograph records of experiments 3, 4, and 5 of the present series are relevant to the question of the nature of the adaptation of reflex claw opening to repeated sensory stimulation.

#### Experiment 3 (fig. 22).

1. The small magnitude of the responses of the right claw com-

Figs. 22-24.

Reflex claw opening responses to light titillator stimuli at the tip of the opened abdomen.

Fig. 22.

Closer tendons intact; opener and closer axons intact.

Stimuli : On the inside of the abdomen at its tip.

Low intensity, low frequency, except stimuli marked with arrows, which are high frequency.

Time : 10 second stimuli : every 30 seconds in 1-13; every 50 seconds in 14-21.

Fig. 23.

Closer tendons cut; opener axons intact.

Stimuli : a Localised rostral, with electrodes in sockets of antennules :  
10 volts, 90 c.p.s., 3 msec.

b At the tip of the inside of the abdomen, with titillator :

low intensity, low frequency, except stimuli 9, 11, 12 : high freq.

Time : 10 second stimuli : every 60 seconds in 2-8; every 30 seconds in 9-14.

Fig. 24.

Closer tendons cut; opener axons intact.

Stimuli : At the tip of the outside surface of the abdomen.

medium-low intensity and frequency in all stimuli.

Time : a 5 second stimuli : every 30 seconds.

b 5 second stimuli : every 30 seconds in 1-6; every 20 seconds in 7-13.

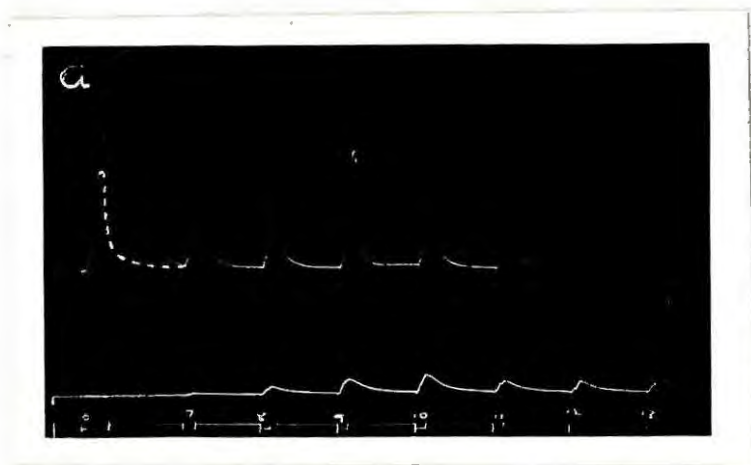
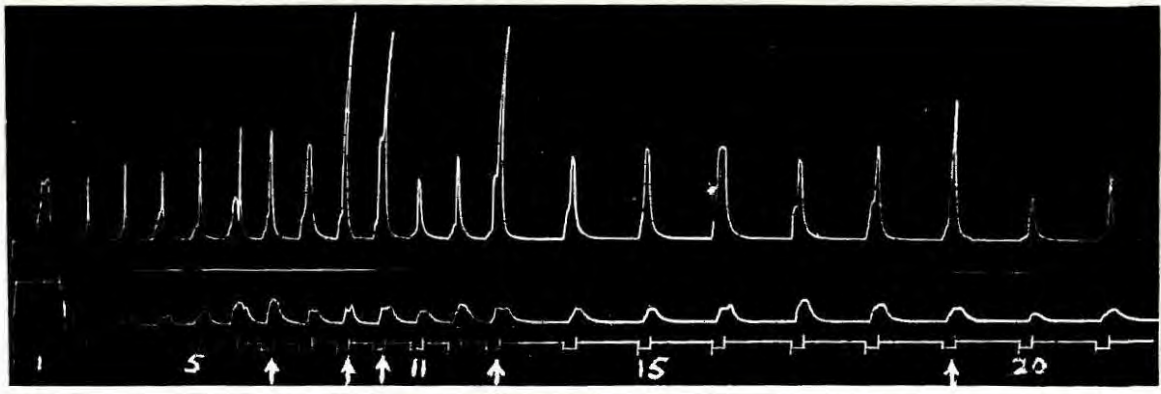

-pared to those of the left claw indicate central or peripheral differentiation between right and left. Because of the complexity of this differentiation, which is indicated by the fact that the magnitude of right and left claw responses did not always vary synchronously, it was probably central, not neuro-muscular-junctional. It is improbable that the small magnitudes of the right claw responses were due to closer muscle antagonism (the closer tendon being intact), as a similar effect has not infrequently been observed in experiments with the closer tendon cut. (see fig 24, for example).

The following observations refer only to left claw responses.

2. The spikes in right claw responses 2 - 6 all occurred on cessation of the respective stimuli, not during the stimuli. They were, therefore, very likely due to release from some form of inhibition which acted during the stimuli. It is highly improbable that this inhibition was neuro-muscular-junctional, since if this were the case, such post-stimulus responses would occur more commonly than they do, and then the effect would involve considerable muscular inefficiency. The post stimulus spikes were, therefore almost certainly centrally determined.

3. The true responses to stimuli 2 - 6, that is, excluding the post-stimulus spikes, are small compared to response 1, and consequently show a marked adaptation of the reflex opening response. Since it was concluded in point 2 that central inhibition was almost certainly suppressing the responses to stimuli 2 - 6, it is reasonable to conclude further that this central inhibition was responsible for the adaptation to stimuli 2 - 6.

4. The gradual increase in response magnitudes, and post-stimulus response heights over responses 2 - 6, suggest build-up of "central excitation", which was further increased by the high frequency stimulus 7, as is shown by the larger response 8. The subsequent high sensory excitation stimuli 9 and 10, superimposed upon this high central excitation, then evoked large responses.

5. The responses following the large responses 10 and 19 also show indications of initial central inhibition, followed by build-up of excitation.

6. The approximate constancy of the responses 14 - 18 was evidently controlled by a balance between excitation and <sup>inhibition</sup> since (a) the height of each of these was greater than that of the evidently purely reflex response 1, this implying further excitation in addition to the purely "reflex excitation", and (b), inhibition was clearly acting on these responses, as is shown by the interrupted contractions. The mechanism of such a balance of excitation and inhibition would undoubtedly be too complex to be maintained in any way other than centrally.

The overall picture suggested by this record is thus one of an initial purely reflex response (1), followed by responses which are modified from the purely reflex form, by adaptation and other variations determined by a balance of central excitation and inhibition. Repetition of these low frequency stimuli causes a gradual build-up of central excitation. When high sensory excitation, produced by high frequency stimulation, is then superimposed upon this central excitatory state, large responses result. This picture is clearly very speculative,

but the main emergent point is the predominance of central control over response variations.

Experiment 4 (fig. 23).

1. Consideration of the record of responses to 10 volt localised rostral stimulation in this figure yields some relevant information. Each of the "spikes" in the left claw responses 1 - 3 commenced on cessation of the stimulus evoking the response, so that, for reasons similar to those given in experiment 3, point 2, they were in all probability the result of release from central inhibition. That the spikes occurred only in the left claw is explicable in so far as the cathode was on the left side, the anode on the right. Hughes (1932) found, in Periplaneta sp., that negative and positive electrodes on a thoracic ganglion have opposite effects on the muscle of a single ganglion -nerve-muscle preparation: the cathode excites and the anode inhibits. In the present instance, the cathode nearest the left cerebral ganglion apparently inhibited the response of the left claw. This may well be attributable to inhibitory influence of the cerebral ganglion on the thoracic ganglion. (C.f. Bethe, 1897.) The post-stimulus spikes in the previous record/might also, therefore, have been due to cerebral inhibition. (fig. 22) The increase and subsequent decrease in response height in both claws in this record seems to have been determined by the stimulus repetition frequency, the faster frequency causing an increase in central excitation and the slower a decrease.

2. After the first response (5) to titillator stimulation, there was a slight adaptation of responses 6 - 8. Although there is little

indication of central control of this adaptation, there was a build-up of excitation over responses 6 - 8, this indicating central influence. High sensory excitation at stimuli 9, 11 and 12 then "triggered off" the existing central excitatory state, evoking the large responses, similar to those of the previous experiment. The high stimulation frequency of stimuli 9, 11 and 12 also initiated high central inhibition, which was only manifested during the subsequent low frequency stimuli, 10, 13 and 14. The erratic opening and closing after-effect following stimulus 14 was possibly a result of central excitation-inhibition antagonism.

The overall picture is similar to that of the last experiment : (a) low amplitude reflex responses, which are subject to adaptation and other centrally imposed variations; (b) build-up of central excitation determined by the stimulus repetition frequency; and (c) high amplitude responses, resulting from superposition of high sensory excitation upon relatively high central excitation.

#### Experiment 5. (fig. 24)

1. The right claw responses were small, as was the case in fig. 22. They varied in magnitude, to a certain extent, inversely as the left claw responses, particularly in d. The significance of this is not clear, but it does give the impression of a high central excitatory state being released, through the opening reflex of either the left or the right claw but not both together at each sensory stimulus.

2. The cumulative capacity of the central excitation is well illustrated by a comparison of the response to the whole 10 seconds of

the first stimulus in a and the response to the first 5 seconds (dotted line). The reason for the large responses 1 and 3 is not clear, but they could conceivably have been due to a large central excitatory state which existed at the time of stimulation, or was rapidly induced by the first stimulus, before prolonged or repeated stimulation had evoked any central inhibition.

3. The maintenance of more or less constant height of responses 7 - 10 was in all probability centrally affected, by a balance of excitation and inhibition, in the same way as the similar effect in experiment 3. The subsequent adaptation of the mechanical response was probably effected in a similar way.

The overall picture is again similar. There were large responses, apparently due to the relatively high stimulation intensity (compared to the previous two experiments) causing a high central excitation; and there were small responses, due, presumably, to strong central inhibition; there were also medium responses, due, apparently, to a balance of central excitation and inhibition.

### 5.8 ADAPTATION TO MECHANICAL SENSORY STIMULI OF OTHER FORMS.

Fig 25g shows the reflex opening responses of a left claw to repeated mechanical sensory stimulation, by high frequency, low amplitude, to-and-fro vibration of the last abdominal segment, by means of the titillator. It is possible, but improbable, considering the low vibration amplitude, that the adaptation was due to sensory adaptation; comparison with fig. 25 h indicates that it was not due to motor fatigue. The slight indication of the "step" effect (c.f. figs. 21 d, 22 and 24)

Figs. 25-27.

Reflex claw opening responses to other forms of light mechanical sensory stimulation.

## Fig. 25a.

Closer tendon cut; opener axons intact.

Stimuli : Vibration of the last abdominal segment backwards and forwards, with titillator : high frequency, low amplitude.

Time : 2 second stimuli, every 15 seconds.

## Fig. 25b.

Closer tendons cut; opener axons intact.

Stimuli : Wire hammer-head of titillator moving transversely in the thoracic groove into which fits the abdomen when closed : high intensity and frequency.

Time : 3 second stimuli, every 15 seconds.

## Fig. 26.

Closer tendon cut; specific opener inhibitor axon transected.

Stimuli : Stroking the sternal plate with a glass rod; intensity medium.

Time : 5 second stimuli, every 20 seconds.

## Fig. 27.

Closer tendons cut; opener axons intact.

Stimuli : Pinching the tip of the abdomen with the forceps; intensity high.

Time : 1 second.

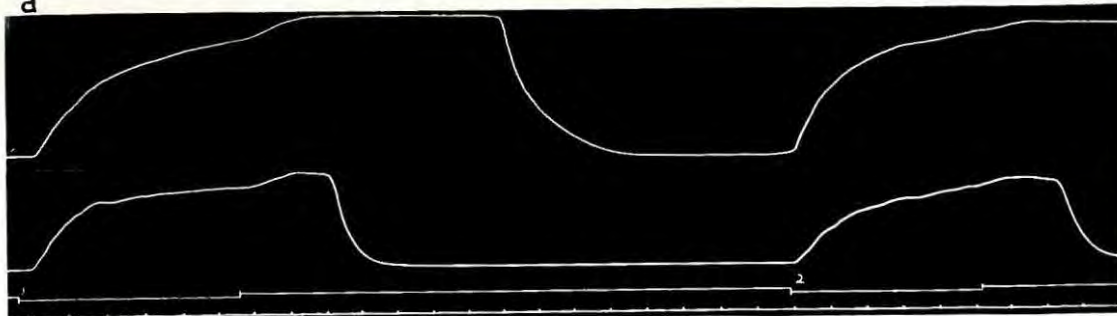
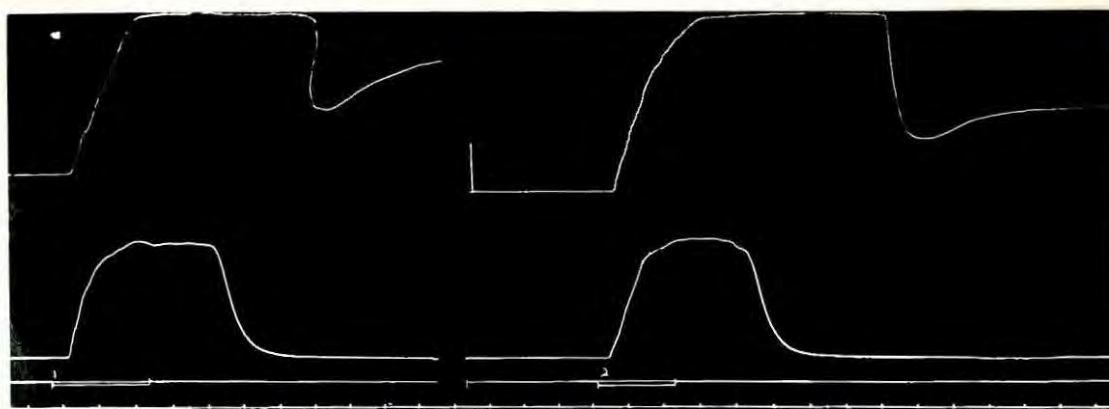
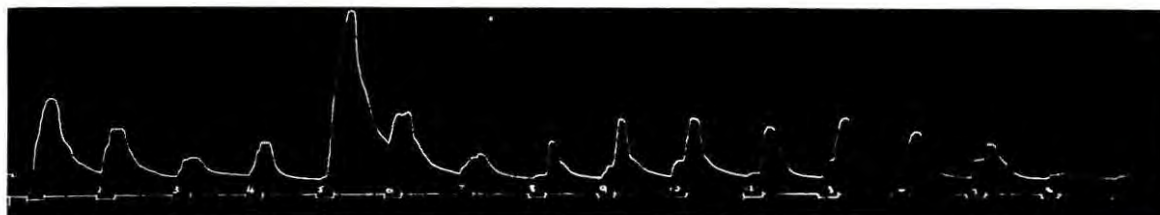
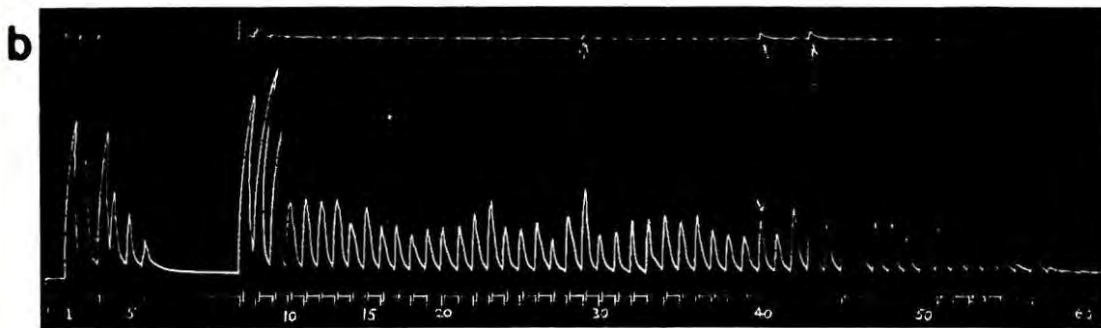
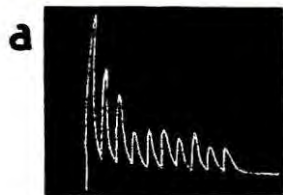

suggests central nervous influence, which makes it probable that the adaptation was, at least partly, centrally determined.

The record shown in fig. 25 b shows reflex claw opening responses to titillator stimulation with the titillator hammer moving transversely in the groove into which the central portion of the abdomen fits when closed. This was a very strong stimulus, and it caused slight injury to the exoskeleton at the place of stimulation. Clearly the adaptation over the first six stimuli was a true adaptation of some kind : the large response 7 could not have been evoked 1½ minutes after the small response 6 had it been due to motor fatigue. The die-away of the responses at the end was due to motor fatigue, as no further opening response could be evoked by any sensory stimulus.

Points of interest are :

1. The almost periodical occurrence of relatively large responses suggests the possible existence of a vague central rhythm of excitation and inhibition.

2. The frequent occurrence of small responses following these large ones suggests central control of a balance of inhibition and excitation. This is further indicated in the tendency for the response heights following a small response to build up gradually towards a large response. Again, as in the previously described experiment, the responses of the other (left) claw were very small. However, the responses of the two claws were largely synchronous, which suggests that the variations in response height were largely due to variation of sensory excitation, which is not surprising considering the strong and injurious nature of the stimulation.

Fig. 26 is a record of right claw reflex opening of the sternal plate with the end of a metal rod. The large response (5) was the result of increased stroking frequency, showing that the adaptation over responses 1 - 4 was a true adaptation. Since the specific opener inhibitor had been transected, this inhibitor was clearly not involved in determining the adaptation.

The other point of interest is the constancy of the heights of responses 9 - 13. Each of the high portions of these responses was evoked following a single quick backwards and forwards stroking movement and was clearly not an after-stimulus contraction. It is possible that the heights were more or less the same because, by pure chance, the stroking stimulus intensities varied in such a way as to maintain the same motor excitation for each stimulus. It is more likely, however, to have been the result of a central effect: possibly the "steps" effect observed previously (see figs. 21 d, 23 and 24 )

Fig. 27 shows records of right and left claw contractions maintained after sharp prolonged pinching of the abdomen. Where the stimulus was maintained for 5 or 6 seconds (b) there was a slight post-stimulus increase in contraction tension, due conceivably to release from central inhibition. The increase in response following the 6-second stimulus was markedly greater than the increase following the 5-second stimulus, whereas there was no increase in response following the stimuli of 2 and 3 second durations (a). This supports the idea of release from central inhibition as causing the post-stimulus increase in response. The rapid relaxations were probably effected by sharp cessation of central excitation, or by sharp central inhibition.

5.9 REFLEX INHIBITION OF CLAW OPENING.5.91 The experiments of Hoffmann on Astacus.

Hoffmann's experiments in which he transected the opener motor axon were the logical sequence to his experiments involving ~~trans-~~section of the opener inhibitor axon. Since the inhibitor transection experiments indicated that the opener inhibitor axon was responsible for the adaptation in Astacus, of the reflex claw opening response to prolonged or repeated sensory stimuli, it was desirable to prove that the opener inhibitor does in fact transmit reflex inhibition to the opener muscle. This he claims to have proved in his motor axon transection experiments. These experiments consisted essentially in transecting the opener motor axon in the carpus and stimulating it electrically distal to the point of section; this evoked a contraction of the opener muscle which could be inhibited reflexly by sensory stimulation of, for example, the tail. In fact, the experiments were not quite as simple as this.

Hoffmann found that when a contraction in the opener muscle was produced and maintained by stimulating electrically and maintaining the stimulus to the distal end of the exciter axon, very strong sensory stimulation, for example, strong electrical stimulation with an electrode inserted between two segments of the abdomen on either side of the ventral nerve cord, was necessary to cause any reflex inhibition at all of this contraction. However, if by chance some tension was maintained in the opener muscle after cessation of the motor axon stimulus this tension could be promptly abolished by reflex inhibition evoked by tactile sensory stimulation of the tail. Similarly, if an "accidental"

tonus was developed by the opener muscle after transection of the opener excitor axon, this tonus could be promptly abolished by tactile sensory stimulation of the tail. Hoffmann however, published no traces of reflex inhibition produced in any of these three ways. The only trace published which he claims to illustrate reflex inhibition is a record of opener responses to regularly repeated motor axon stimuli, between which stimuli were interspersed, also at regular intervals but less frequently, electrical sensory stimuli applied to the ventral surface of the abdomen with an electrode on either side of the ventral nerve cord. The opening responses immediately following the sensory stimuli were considerably smaller than the succeeding responses, which increased progressively in size until the next sensory stimulus. This trace is reproduced in fig. 28. This effect Hoffmann states to be the result of the after-effect ("Nachwirkung") of reflex inhibition, which he says sometimes lasts for 30 seconds or more.

#### 5.92 Experiments with the opener motor axon transected.

Unfortunately in the present experiments on Botanion no experiments of this last form were made. In any later extension of this work it is desirable that experiments of this form should be made. On the few occasions on which a "accidental" tonus was developed in the opener muscle after transection of the opener motor axon, the titillator or sensory stimulation electrodes were not ready for sensory stimulation, since it was the normal procedure to allow the preparation to rest after transection of a nerve before experimenting.

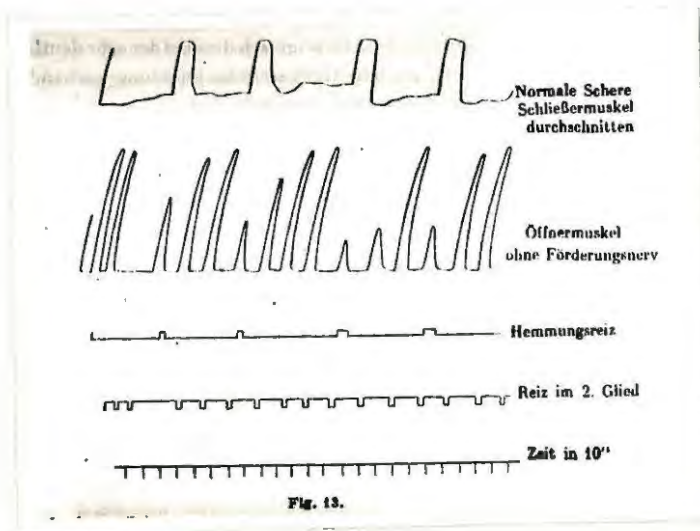

Fig. 13.

Fig. 28.

Reproduction of a record of Hoffmann (1914), showing inhibitory after-effect (Nachwirkung) of electrical stimuli to the abdomen, on claw opening responses to stimulation of the thin cheliped nerve, in Astacus.

Upper responses : opener axons intact.

Lower responses : opener motor axon transected and stimulated peripherally.

Motor stimulus : applied to the "thin nerve" in the carpus.

Sensory stimulus : applied with an electrode on either side of the ventral nerve cord in the abdomen.

Time : 10 seconds.

Further attempts should however be made to repeat the experiment in this form. With the rather strong recording lever springs which were used in these experiments, tension in the opener muscle was on no occasion maintained after cessation of a stimulus to the opener motor axon, so that a repetition of this form of experiment made by Hoffmann was also not accomplished. Again this should be attempted in further experiments, preferably using lighter recording lever springs as was done in the preliminary innervation experiments, in some of which some tension was maintained in the opener muscle after cessation of axonal stimulation.

Only four experiments were successfully done in which one or more mechanical sensory stimuli were applied during a contraction of the opener muscle evoked and maintained by electrical stimulation of the transected opener motor axon. In all four of these experiments the sensory stimuli were applied with the titillator to the tip of the abdomen on either the outside surface (in the first three experiments) or on the inside surface. The axonal stimuli were of 0.05 to 0.1 volts amplitude, 80 to 100 c.p.s. and 1.5 msec. pulse duration. In two of these experiments no indication at all of reflex inhibition was observed; the tension developed by the opener on motor axon stimulation was large, but not large enough, with the recording lever springs used, to produce maximal anatomical opening of the dactylus. A record from one of these two experiments is shown in fig. 29 a. However in the second trace of the same record (fig 29 b), and also in the first and last of the present four experiments (fig. 29, c and d), latter being also the last experiment done in this work, a slight but nevertheless distinct indication of reflex inhibition was obtained, particularly in the last experiment.

**Fig. 29.**

Records showing reflex inhibition (or absence thereof) of claw opening responses to stimulation of the opener motor axon, by mechanical sensory stimuli to the abdomen.  
Opener motor axon transected.

**Fig. 29a, b.**

Motor stimulus : 0.1 volts, 100 c.p.s., 1.5 msec.  
Sensory stimulus : medium intensity titillator, on outside surface of abdomen.  
Time : 10 seconds.

**Fig. 29c.**

Opener contraction resulted from lifting opener motor axon on the electrode.  
Sensory stimulus : medium intensity titillator, at tip of abdomen on outside.  
Time : 10 seconds.

**Fig. 29d.**

Motor stimulus : 0.1 volts, 80 c.p.s., 1.5 msec.  
Sensory stimulus : low intensity titillator, at tip of abdomen on inside.  
Time : 60 seconds.

**Fig. 30.**

Records showing inhibition of claw opening during and after high voltage electrical stimulation of the abdomen. The claw opening was maintained for long periods after electrical abdominal stimulation. The inhibition in a was caused by stroking the cutting edge of the claw at y and yl. The inhibition in b occurred with no apparent external stimulus.  
Time : 5 seconds.

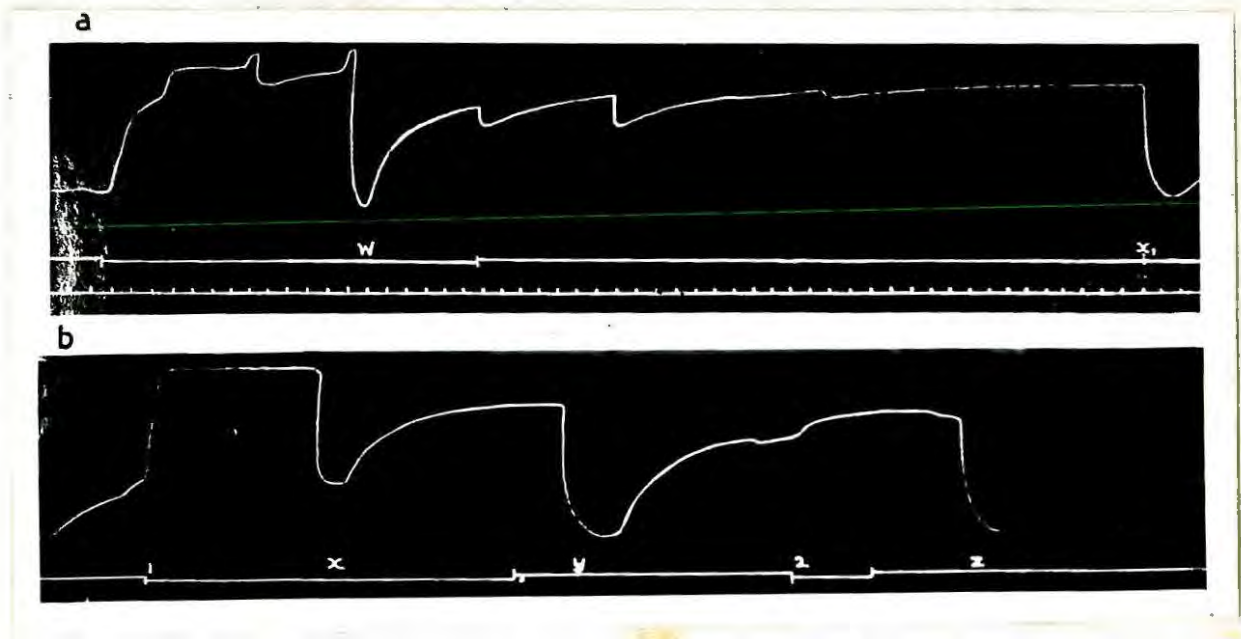
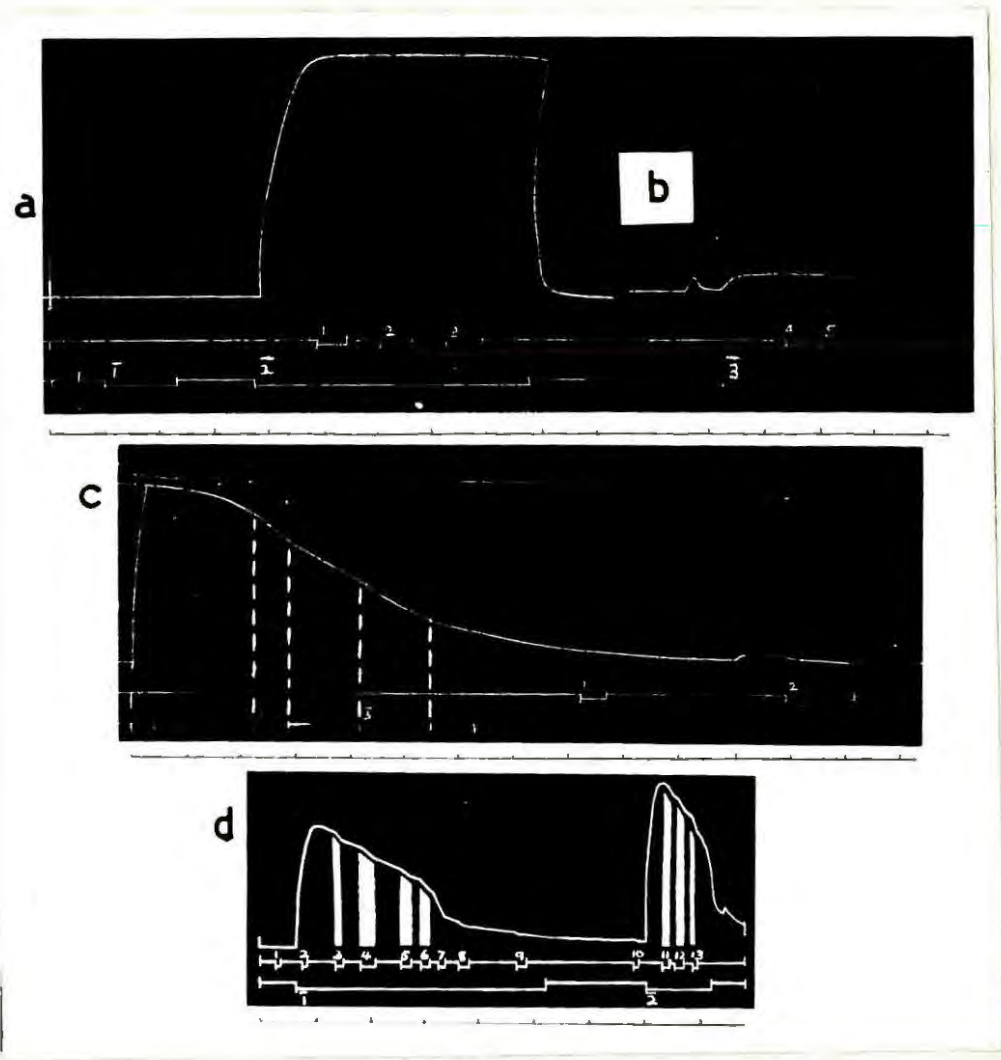

Although the inhibition of the contraction as recorded kymographically was very slight, it was very clearcut as seen visually.

5.93 Other experiments with opener axon intact.

Occasionally, in about four different experiments on crabs in which the opener axons were all intact and the antagonistic closer muscle tendon was cut, clear indications of reflex inhibition were obtained. Normally in the intact animal with intact closer muscle tendon, a light tactile stimulus on the cutting edge of either the dactylus or the immovable ramus of the propus evokes a prompt closing reflex in that claw. In one crab in which the closer tendons of both claws were cut through, a slight tension in the opener muscle of each claw was maintained against the tension of the recording lever springs so that each claw was about half open. A light tactile stimulus to the cutting edge of each claw caused prompt closing of that claw, each claw being pulled closed by its recording lever spring. This was clearly reflex inhibition of tone in the opener muscles. But since the opener axons were all intact, the inhibition could have <sup>been</sup> either a central inhibition of activity in the opener motor axon or peripheral inhibition at the neuro-muscular junction by the opener specific inhibitor and/or the common inhibitor. The same effect was observed in two other animals.

Fig. 30 a is a record showing reflex inhibition of a contraction of the opener muscle of a claw with the opener axons intact but with the closer tendon cut. In this experiment one of the very light recording lever springs was used. The contraction was evoked reflexly by electrical stimulation of the tip of the abdomen on its inside surface, at

40 volts, 100 c.p.s. and 400 msec. The reflex inhibition, at x, was evoked by a light tactile stimulus on the cutting edge of the claw. The redevelopment of tension after cessation of the sensory stimulation suggests the after-effect of strong central excitation resulting from the high amplitude electrical stimulus. During this maintained tension the cutting edge of the claw was again lightly stroked, at x<sub>1</sub>, causing another relaxation through reflex inhibition, after which tension in the opener muscle began slowly to redevelop again. Here again the inhibition could have been either central or peripheral. The relaxations at x, y, and z in fig 30 b, of the opener muscle tens, both during and after electrical sensory stimulations similar to those for fig. 30 a, were "spontaneous", as no known sensory stimulations of any form were applied apart from the electrical sensory stimuli indicated by the signal marker, and there was no variation in this at x. This suggests some form of central inhibitory influence, but whether on the excitatory and/or on the inhibitory axons to the opener muscle is unclear.

#### 5.94 Conclusion.

From these meagre results on reflex inhibition two conclusions may be drawn.

1. Reflex inhibition of muscle tone does occur in Potamon.
2. It is possible that neuro-muscular junctional inhibition by way of the opener specific inhibitor axon and/or the common inhibitor axon is partially or wholly responsible for this inhibition.

However, what evidence there is from these experiments, albeit not very critical evidence, indicates central inhibition of activity in the opener motor axon, rather than inhibition at the NMJ by the opener and/or common inhibitor axons, as the causative factor in the reflex inhibition. Firstly, the degree of inhibition of claw opening was very slight in the experiments with the opener motor axon transected (section 5.92), but was very much greater in the experiments with opener motor axon intact (section 5.93). This observation is however not very meaningful, since different forms of sensory stimulation were used, and the opener contraction was evoked in different ways, in the two groups of experiments, so that the results are not strictly comparable. Secondly, the reflexly evoked opener relaxations in fig. 26 a were very similar in character to the "spontaneous" relaxations in fig. 26 b, which were almost undoubtedly due to central inhibition (or at least cessation) of activity in the opener motor axon, and were, therefore, probably also caused by central inhibition.

Clearly, further experiments are required; in particular, experiments in which the opener motor axon is transected, and inhibition of claw opening is produced, if possible, by stroking the inside of the claw.

## 5.10 CONCLUSION.

It has been shown (section 5), in Notanion perlatus, that reflex claw opening responses to sensory stimuli do become adapted, both in response magnitude and sometimes also in response duration, when the sensory stimuli are regularly repeated. It has also been shown that a contraction of a claw opener muscle may be reflexly inhibited by sensory stimuli. The two phenomena are probably, but not necessarily, effected by the same mechanism. The mechanisms of the two phenomena will first be considered separately.

### 1. Adaptation to repeated sensory stimuli.

In the experiments of sections 5.4 - 5.5 and 5.7 - 5.8, transection of the opener inhibitor and the common inhibitor axons made no apparent difference to the adaptation of the mechanical responses or reflex claw opening. It may be concluded, therefore, that neither the specific opener inhibitor axon nor the common inhibitor axon is involved in adaptation of reflex claw opening to repeated sensory stimuli. That is, the reflex claw opening adaptation is not affected by simple reflex inhibition via one or both of these two inhibitor axons, as Hoffmann concluded was the case in Astacus.

As was concluded in section 5.5, the clearcut mechanical adaptations of reflex claw opening which occurred in the experiments of sections 5.3 - 5.5, were due largely to sensory adaptation resulting from the strong sensory stimuli used. This sensory adaptation obscured any other adaptation which might have occurred. On the other hand, in the experiments of sections 5.6 - 5.8, in which sensory adaptation did not

occur, the sensory stimuli being relatively light, another form of adaptation of reflex claw opening was apparent. The mechanical adaptation in these experiments was not due to motor fatigue or sensory adaptation. Furthermore, in the only critical experiment of these sections (experimental section 5.7), transection of the specific opener inhibitor axon and the common inhibitor axon made no apparent difference to the mechanical adaptation of reflex claw opening, as stated in the previous paragraph, so that, clearly, the mechanical adaptation was not effected by simple reflex inhibition via these inhibitor axons. In fact, the evidence from these experiments, albeit not critical, all points to the mechanical adaptation having been brought about by central adaptation of some form.

Consideration of the meagre experimental evidence as to the nature of the central adaptation, although this involves a considerable amount of speculation, as has been emphasised, suggests that the central "adaptation" may in fact be produced by central inhibition, at the central synapses, of the reflex excitation. Furthermore, there appears to be considerable flexibility in the central control of reflex activity. From the experiments quoted in section 5.7, there appear to be at least three "levels" of central adaptation control, which act at different levels of the reflex excitation caused by sensory stimulation of the lower intensity than the threshold for sensory adaptation. Thus, with fairly strong sensory stimulation, though not strong enough to cause sensory adaptation, strong reflex claw opening responses are evoked and maintained, apparently by maintenance of a high level of central excitation with little adaptation, as for example the large responses to higher frequency titillator stimulation in figs. 22 and 24. At

low frequencies and intensities of sensory stimulation, as for instance in the small responses in figs. 22 and 23, central inhibition appears to act on the reflex excitation, causing central adaptation, this in turn producing the mechanical adaptation seen in the kymograph recording. Sometimes, also, with medium intensity sensory stimulation the reflex responses are maintained at a fairly constant level, as for instance, in the medium height responses in fig. 24, this, perhaps, being due to fairly high central excitation, with a constant degree of blocking of central synapses by central inhibition.

The discussion in the last paragraph is obviously highly speculative, and is intended more as a possible, albeit rather liberal, interpretation of the central nervous mechanisms involved than as a working hypothesis or explanation of them. The main conclusion emerging from the present experiments on reflex claw opening in response to mechanical sensory stimulation, is that the adaptation of reflex claw opening responses to repeated sensory stimuli, when these are not strong enough to cause sensory adaptation, is centrally determined, and is not dependent upon the activity of either (or both) the specific opener inhibitor axon or/and the common inhibitor axon. The sensory adaptation which occurs at high stimulation intensities probably serves to "safeguard" the central nervous system against too great excitation.

Clearly, further and more comprehensive experiments are required, (a) to confirm this main conclusion, and (b) to help clarify the picture of the central nervous mechanisms underlying the adaptation of reflex claw opening to sensory stimulation. Firstly, extensive axon transection experiments, along the lines of the present experiments,

should be made to cover, comprehensively, all the possible functional combinations involved in the adaptation of reflex claw opening. Secondly, extirpation experiments designed to eliminate, systematically, the right and/or left halves of each of the cerebral, suboesophageal, cheliped, walking leg, and abdominal ganglia, would help to localise the central nervous elements involved in the adaptation of reflex claw opening. And thirdly, the mechanism of the adaptation would be considerably elucidated by oscillograph recordings, during sensory stimulation, of the electrical activity in the opener muscle, in the opener motor and inhibitor and common inhibitor axons, in the central ganglia, and in the sensory nerve fibres of the claw opening reflex. Thus, if the activity elicited in the opener motor axon by sensory stimulation decreases with maintained or repeated sensory stimulation, and if there is no simultaneous decrease in activity in the relevant sensory fibres, then the mechanical claw opening adaptation can with certainty be attributed to central adaptation. Electrical recordings from the cheliped ganglion, isolated with only the sensory and motor elements of the claw opening reflex arc, might then throw some light on the nature of the central adaptation.

## 2. Reflex inhibition of claw opening.

It has been concluded, at the end of section 5.9, that peripheral inhibition via the opener inhibitor or common inhibitor axons is not an important causative factor in the mechanical/<sup>opening</sup> inhibition which is sometimes reflexly produced by sensory stimulation. What little experimental evidence there is indicates that any reflex inhibition, of a "spontaneous" or reflexly elicited opener contraction, that might result from sensory stimulation,

is in all probability centrally determined. This followed from the observations that (a) only very slight inhibition of opening resulted from abdominal sensory stimulation when the opener motor axon was transected; (b) much greater inhibition was produced, by stroking the cutting edge of the claw, when the opener axon was intact; and (c) the opener relaxation in (b) was very similar in character to subsequent relaxations which were apparently "spontaneous", and therefore, presumably, centrally determined. However, in view of the paucity of the evidence, this can only be a very tentative conclusion.

Clearly further experiments are required. In the first place, it is necessary to repeat the experiments involving transection of the opener motor axon, to see if greater degrees of inhibition of opener contraction, evoked in any way, can be produced by abdominal sensory stimulation. It is, however, unlikely that this will be possible, to any significant extent, since the only conceivable function of reflex inhibition produced in this way would be to effect adaptation of reflex claw opening in response to the same sensory stimulation as causes the reflex inhibition, as in Astacus; and the adaptation experiments have indicated that the adaptation to light sensory stimulation is centrally determined, and is not dependent upon the opener or common inhibitor axons.

Secondly, experiments should be made to see if opener muscle contraction can be inhibited, by stroking the cutting edge of the claw, when either the opener motor axon, or the opener and/or common inhibitor axon(s), are transected. As observed in section 5.93, stroking the cutting edge of the claw inhibits opener contraction when all the opener axons are intact. If transection of the opener and/or common inhibitor axon(s) does not prevent

this reflex inhibition of opener contraction, but transection of the opener motor axon does, then the reflex inhibition produced by stroking the cutting edge of the claw, of "spontaneous" or reflexly elicited opener contraction, will in all probability be due to central inhibition of the opener motor axon activity causing the opener contraction. This central inhibitory mechanism effecting "reflex inhibition" would then almost certainly be the same as that for effecting adaptation of the claw opening reflex.

On the other hand, if, after transection of the opener inhibitor axon, it is no longer possible to inhibit opener contraction by stroking the cutting edge of the claw, then clearly the opening inhibition produced in this way will be due to simple reflex inhibition via the opener inhibitor axon. If this is so - and it is not improbable, from such experimental evidence as there is - then it will be conceivable that the primary function of the opener inhibitor axon in the cheliped of Petamon is to inhibit an opener contraction when an antagonistic closer response is reflexly activated, the inhibition itself resulting from reflex activation of the opener inhibitor axon by the same sensory stimulus as evokes the closing reflex response. This would economize on muscular energy in both the closer and the opener muscle and would permit greater efficiency of contraction of the closer muscle. It seems possible, therefore, that reflex inhibition of this kind, of antagonistic reflex motor responses, is the primary function of all the individual inhibitor axons of the limbs of the Decapod Crustacea. This possibility will be considered further in the final discussion.

And thirdly, as in the previous section on adaptation, appropriate  
 of  
 oscillograph recordings/ opener and closer muscle and motor and inhibitor axon electrical activity would help elucidate the mechanisms of reflex inhibition.

## 6.0 CENTRAL, DIRECT, AND REFLEX EFFECTS ON CLAW OPENING OF ELECTRICAL SENSORY STIMULATION.

### 6.1 INTRODUCTION.

During the course of the attempts to repeat Hoffmann's experiments, various forms of electrical stimulation were tried in searching for suitable sensory stimuli to evoke the claw-opening reflex. Three main types of electrical sensory stimulation were found to be successful in evoking what appeared to be reflex opening of the claws. These were "localised" rostral stimuli, "general" rostral stimuli, and "localised" abdominal stimuli. The term "localised" here refers to stimuli applied with the two electrodes 1 - 5 mm. apart, and the term "general" to stimuli applied with the electrodes 5 - 50 mm. apart. In both localised and general stimuli, however, the resultant muscle response may be a response to nervous or muscular stimulation over a small specific region or over a relatively large region of the body. In the experiments, as will be pointed out, it is often questionable as to whether a muscle response was one to specific nervous or to extensive nervous and possibly also muscular stimulation.

Almost invariably with each crab experimented upon, except in the early exploratory stages, mechanical sensory stimulation was tried first as a means of evoking a suitably clearcut opening reflex. If however this failed, which was not infrequently the case (about 30 - 40% of the animals used), electrical sensory stimulation of various forms was then tried. The reason for trying mechanical stimuli before electrical was that the high voltages of electrical stimuli usually required to evoke any claw opening responses were more likely to produce extraneous effects, due for instance, to current wandering within the animal, than were the more

restricted mechanical stimuli. The advantage of electrical over mechanical stimulation, on the other hand, was that the characteristics (e.g. amplitude, frequency) of the electrical stimuli were more easily controllable than those of the mechanical stimuli. However, this disadvantage of the mechanical stimulation was considered to be outweighed by its advantage described above.

#### 6.1 LOCALISED ROSTRAL SENSORY STIMULATION.

Fig. 31 shows opening of the right claw in response to electrical localised rostral stimulation in a crab in which only slight reflex opening could be evoked in response to titillator stimulation on the outside surface of the abdomen. Both traces were made with only the opener motor axon intact. Before the opener inhibitor axons were transected, the reflex opening response to titillator stimulation was not significantly different from that shown here,

Fig 32 shows two records from different crabs with closer tendons intact of claw opening in response to localised rostral stimulation of increasing amplitudes. In both claws clearcut opening occurs only at the maximum amplitude used, namely 50 volts. However this does not eliminate the possibility of the closer muscle having been excited to contract at lower voltages, since the base-line represents complete or almost complete closure. Clearly more complete closure did occur in the right claw at stimulus no. 5 in a. It is possible that in this claw the activity of the closer muscle suppressed the activity of the opener muscle. In b, all the large left claw responses except responses 8 and 9 commenced on cessation

Figs. 31-33.

Claw opening responses to "localized rostral" electrical stimulation.  
Stimulating electrodes placed 3-4 mm. apart on the flat supra-rostral  
exoskeletal surface.

Time : 5-second stimuli.

Fig. 31.

Closer tendon cut; opener inhibitor axon cut.

Stimuli : a, b Medium intensity vibrator stimulation on outside surface  
of abdomen.

g Electrical stimulation on rostrum : 30 volts, 100 c.p.s., 4msec.

Fig. 32.

Closer tendons intact; opener axons intact.

stimuli : Rostral a 10, 20, 30, 40 volts in stimuli 1, 2, 3, 4, respectively, and  
50 volts in stimuli 5-17; 100 c.p.s.: 5 msec.

b 20, 30, 40 volts in stimuli 1, 2, 3, respectively, and  
50 volts in stimuli 4-9; 100 c.p.s.: 5 msec.

Fig. 33.

Right closer tendon intact; left closer tendon cut; opener axons all intact.

stimuli : Rostral : 40 volts, 100 c.p.s., 3 msec.

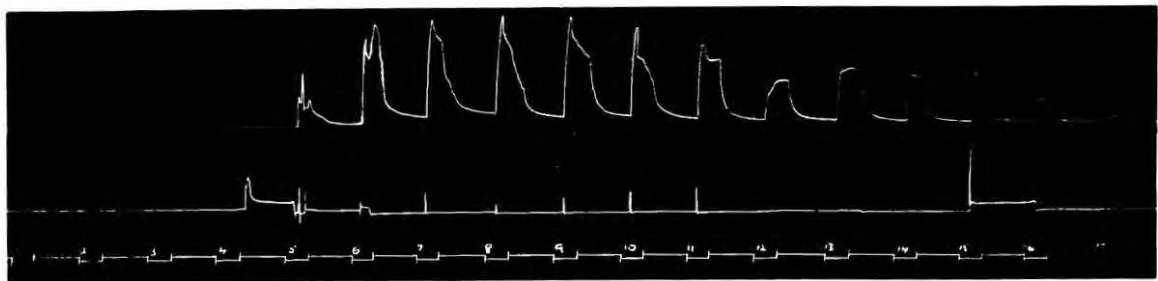
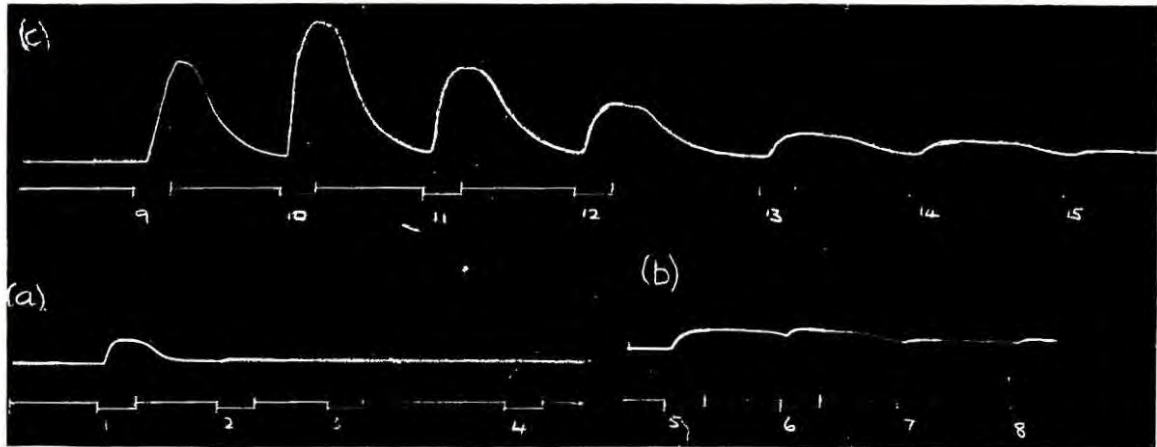

a

b

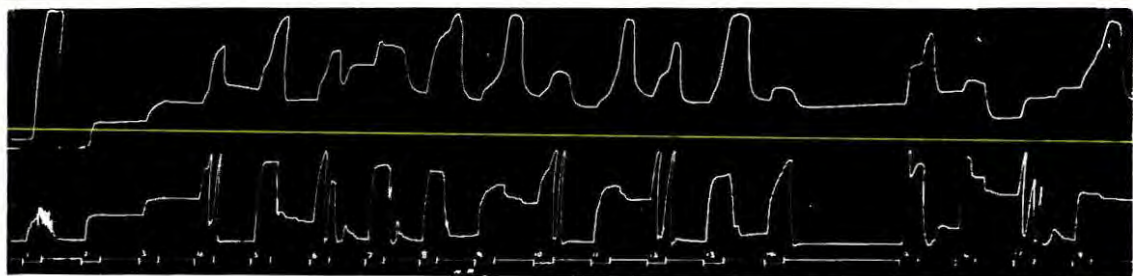
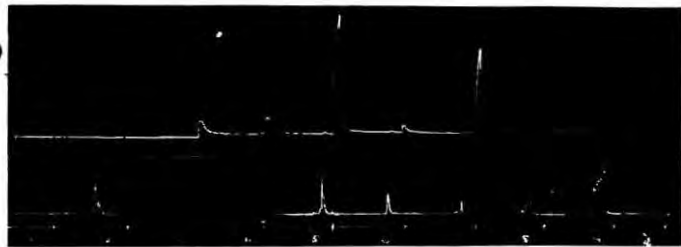

of each stimulus. This occurrence of post-stimulus responses strongly suggests release from central inhibition, and recalls the post-stimulus spikes in figs. 22 and 23. The most likely form of central inhibition to result from rostral stimulation would be inhibition by the cerebral ganglion so that this evidence points to any central inhibition which occurs as being cerebral.

Sometimes the antagonism between opener and closer muscles, when high intensity rostral stimulation is applied, is manifested as alternate opening and closing, as in the right claw response in fig. 33 ( cf. response of left claw whose closer tendon was cut). Subsequent transection of the right closer tendon abolished this effect. Other points of note in fig. 33 are : (a) the gradual build-up of response height after the large left claw response 1; (b) the occasional alternate large and small responses ; and (c) the close similarity in heights of the large responses (this was not due to maximal anatomical opening). Similar effects were observed in various reflex adaptation experiments with titillator stimulation ( section 5.64, fig. 21). In section 5.64 these effects were attributed to central nervous influence. The present occurrence of similar effects supports the idea of central influence, and suggests, further, that the cerebral ganglion enters, to some extent, at least into this central influence.

The record shown in fig. 23 a, of responses of both claws to rostral stimulation of 10 volts, shows that such stimulation can produce clearcut opening responses similar to those evoked by titillator abdominal stimulation (fig. 23 b). Furthermore, in the left claw responses of a, the post-stimulus spikes strongly suggest a differential effect on left and right sides, of the directional current. The cathode was on the

left, that is on the same side as the claw which yielded the post-stimulus spikes. This is in agreement with the idea that the cerebral ganglion has an inhibitory effect on the rest of the central nervous system; that is if the post-stimulus spikes are the result of release from inhibition as was suggested (section 5.7). This, then, is further evidence for any strong central inhibition which might act on the claw opening reflex being determined by the cerebral ganglion.

### 6.3 " GENERAL" ROSTRAL ELECTRICAL STIMULATION.

When instead of both cathode and anode being placed within 5 cms. of each other on the rostrum, the anode was placed in some soft spot on the ventral surface of the animal posterior to the cathode on the rostrum, markedly bigger and more clearcut opening responses|in both claws

were obtained. This is because such "general rostral" stimulation does in all probability, have a general stimulatory effect on the nervous system, and thereby stimulates directly the cheliped nerves, causing the more clear-cut responses. This supposition is borne out in the observations which follow. The experiments from which these observations were made were initially carried out to test the potentialities of this form of "sensory" stimulation for evoking reflex claw opening. When it was concluded that such rostral stimulation was in fact general and therefore not suitable for this purpose, one or two further experiments were made to explore the effects of this type of stimulation.

#### 6.31 General rostral stimulation with all tendons and axons intact.

In an exploratory experiment the responses of the cheliped dactyli were observed, but not recorded, for electrical stimulation of 10 to 50 volts, with one electrode on the rostrum and the other electrode in various spots on the ventral surface of the crab. With the anode (earth) on the rostrum it was not possible to evoke any response of the cheliped dactyli no matter where the cathode was on the crab. With the cathode on the rostrum and the anode on various ventral soft spots it was possible to evoke either opening or closing in each claw. The cheliped dactyli responses were most marked when the anode was in one of three spots, namely in the socket in which articulates the coxae of either right or left cheliped, or on the inside surface of the last abdominal segment. Responses with the anode in other spots were less clearcut variations of these three types, and will not further be mentioned. The responses with the anode in each of the three places mentioned were most marked at

voltages of 30 to 50 volts, and they did not vary within this voltage range; below 30 volts the responses were smaller and sometimes erratic and not clearcut. Variations of pulse frequency or duration did not alter the type of response.

Rostral stimuli with the anode on the inside surface of the abdomen caused opening of both left and right cheliped dactyli. With the anode in the socket of the right cheliped, stimuli caused opening of the left claw and closing of the right claw. Conversely, with the anode in the socket of the left cheliped, stimuli caused opening of the right claw and closing of the left claw.

The response of the claw with the anode in its socket is best interpreted as having been due to direct stimulation of its nerve. Applying increasing amplitudes of stimulation to the claw nerve of Sarcinus moenag. Pantin (1934) found that at low amplitudes the opener muscle contracted, then at higher amplitudes this was inhibited and the closer muscle contracted, then both closer and opener were inhibited, and then at high amplitudes the closer muscle broke through the inhibition into a strong contraction. A similar break-through from inhibition was found at about 10 volts in a similar experiment in the present work on Potamon perlatus. It is possible that this is the effect of the rostral stimulation, namely that it stimulates the whole cheliped nerve at a high amplitude above the closing-inhibitory values, thus causing closing.

The interpretation of how rostral stimulation effects the contralateral claw is less simple. The opening response could be a response to direct stimulation of sensory nerves (i.e., reflex response) or to direct stimulation of the cheliped ganglion or other parts of the C.N.S.

or to relatively low amplitude stimulation of the nerve of this claw, or to a combination of these. Low amplitudes of about 0.5 to 1.5 volts had previously been found to cause opening response to direct claw nerve stimulation. (c.f. Pantin's opening response at low amplitudes in Carcinus. It is probable that a combination of these factors was involved, since there was probably a considerable current spread, the current density decreasing with distance from the two electrodes, where it would be greatest. However for the present purpose it will be adequate to assume the simplest of these four alternatives to be the correct one, namely that the claw furthest from the anode opens in response to direct low amplitude stimulation of its own nerve.

The opening of both claws in response to rostral stimulation with the anode on the inside of the last abdominal segment will for present purposes also be assumed to be simply a direct response to electrical stimulation of the opener motor axon of each claw.

Fairly consistent effects were also observed in the responses of the walking legs to these three types of rostral stimulation. These, however, are irrelevant to the present work.

Fig. 35 shows the responses of the two claws of a crab which was stimulated with the cathode on the rostrum and the anode in the dissected right cheliped merus, both with (35 h) and without (35 g) the antagonistic dactylus tendons cut through. Closing of the right claw and opening of the left claw were obtained in response to any stimulus voltage between 10 and 50 volts. The minimal required voltage here is markedly lower than that of the previous experiment, owing, probably to the anode being inserted into the opener merus in this experiment. The responses

Figs. 35-36.

Claw opening and closing responses to "general rostral" electrical stimulation,  
Opener and closer axons all intact.

Fig. 35

Opening in left claw (upper trace); closing in right claw (lower trace).

a Opener and closer tendons intact in both claws.

b Closer tendon cut in left claw, opener tendon cut in right claw.

Stimuli : Cathode on rostrum, anode in fluid in the opened right merus.

16 volts, 80 c.p.s., 4 msec.

Time : 5-second stimuli : every 45 seconds in a and b (9-18);  
every 30 seconds in b(1-18).

Fig. 36.

Opening responses of both claws in response to alternate general rostral  
stimuli and opener motor axon stimuli.

Closer tendon of both claws cut.

Specific opener inhibitor axon and common inhibitor axon :

a intact in both claws

b transected in left claw

c transected in right claw (left claw not responsive)

Stimuli : General rostral stimulus :

cathode on rostrum; anode in merus of :

a, b left claw

c right claw

a, b 40 volts, 80 c.p.s., 4 msec.

c 50 volts, 80 c.p.s., 4 msec.

Opener motor axon stimulus :

cathode on axon, anode in merus.

a, b 0.1 volts, 100 c.p.s., 1.5 msec.

c 0.5 volts, 100 c.p.s., 1.5 msec.

Time : same scale as in fig. 35.

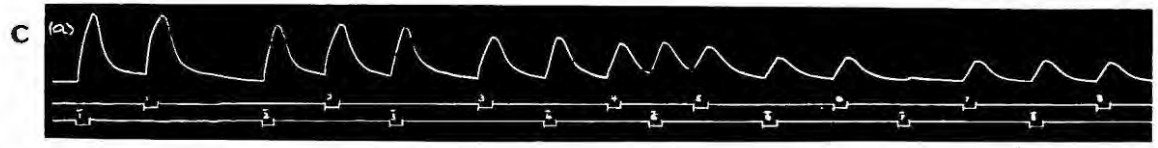
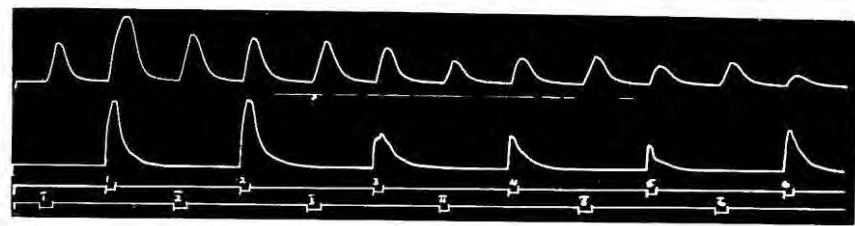
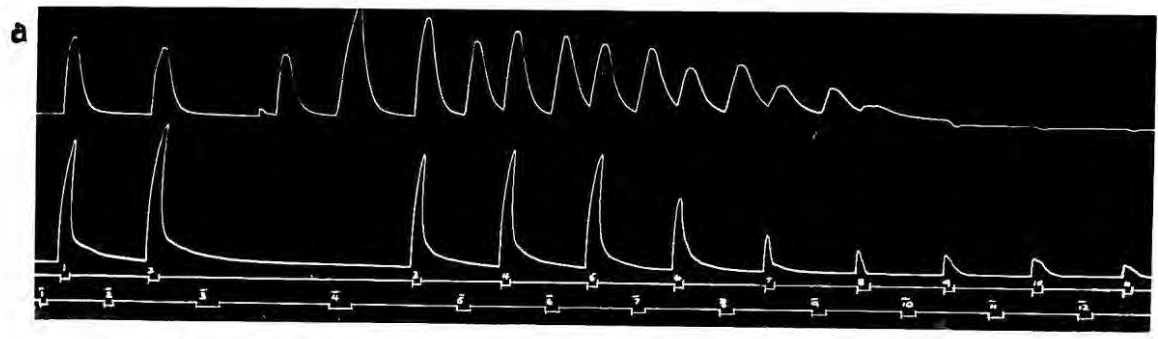
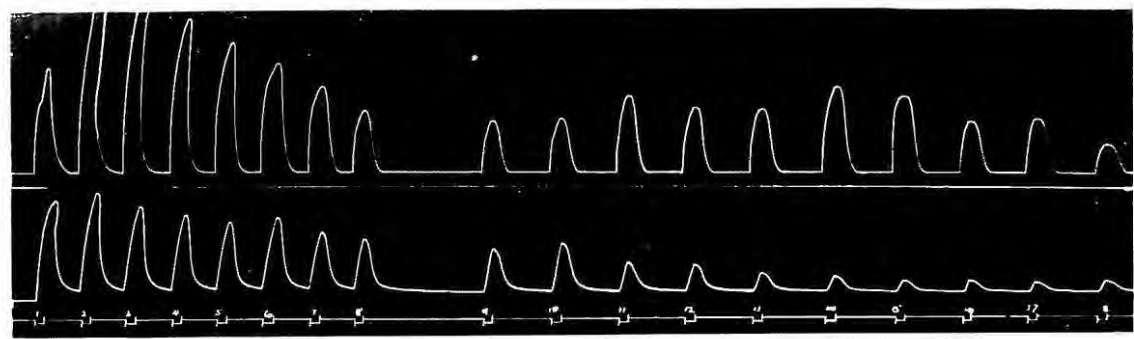
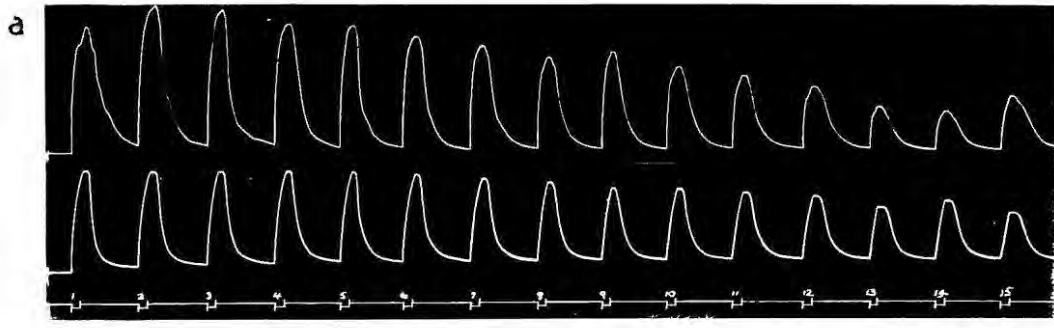

of both claws decreased gradually in magnitude, faster in the left opening responses than in the right closing responses. The rate of decrease was greater with the higher stimulus repetition frequency in responses b 1 - 8, as was to be expected from motor fatigue if the responses were due to direct stimulation of the claw nerves. These observations are in accordance with those of the previously described experiment, <sup>and</sup> with those of a third experiment of this form. The latter experiment will not further be mentioned since it yields no conflicting or additional results.

6.32 General rostral stimulation with closer tendons cut and axons all intact or opener inhibitors cut.

When both cheliped closer tendons were cut and opening recorded in both claws, the claw with the anode in its base responded by opening only slightly or sometimes not at all, while the contralateral claw responded by clearcut (in the previous section (6.31) ) opening. This is understandable if it is again assumed that the general electrical stimulus excited the ipsilateral claw nerve above the opener inhibitor axon threshold, thus inhibiting any contraction of the opener muscle initiated by excitation of the motor axon. If the opener inhibitor axons of the ipsilateral claw were then cut, there was no change in the effect on this opener muscle of general rostral stimulation. This suggests that the electrical excitation excited the opener axons distal to the point of transection of the inhibitors in the nerve. However, if the opener motor axon of this claw was held out of the saline in the nerve, then this opener muscle responded with large and clearcut contractions to each general stimulus, its responses being larger than those of the other claw. It thus appears that holding the opener motor axon out of the

saline in the merus had the effect of localising onto it the general rostral stimulation.

Fig. 35 shows records of opening of both claws, with the opener motor axon of one claw held on an electrode and out of the saline in the merus, in response to general rostral stimulation with the anode in the left merus in a and b, and in the right merus in c. The opener motor axon was stimulated directly, with its electrode, alternately with the general stimuli, each direct stimulus evoking an opening response. In the left claw response in a it is clearly seen that, after the motor axon was submerged in saline at stimulus 8, no subsequent rostral stimulus evoked any opening response; subsequent stimuli did, in fact, cause slight further closure. This is good evidence that the general stimuli had directly excited the left opener motor axon at the points at which it entered the surface of the saline. Since nervous conduction along the opener motor axon was in all probability blocked by slight injury to the axon at its point of contact with the electrode (see section 4.6), the general stimuli must have excited the axon at its distal point of entry into the saline. After submergence excitation of closer /the opener motor axons apparently denuded excitation of the opener motor axon. But, since the closer tendon of this claw was cut, the slight extra closure of the dactylus was not due to the pull of the contracting closer muscle, but was probably due simply to a "taking up of the slack" (resulting from the closer contraction) by the recording lever spring tension. Further evidence for the direct effect on the opener motor axon of the general stimulation is the similarity between the rates of fatigue of the responses to the general stimuli and the alternate responses to the direct axonal stimuli, both in the left claw in a and b and

in the right claw in g. The slight difference between the two rates of fatigue in the right claw in a may at least partly be attributed to the different durations of general and direct stimuli, since the fatigue of the axon-muscle combination would be greater after the 3-second duration direct stimuli than after the 2-second duration general stimuli. The greater and more irregular rate of fatigue in the right claw than in the left claw in a and b is explicable if the excitatory effect of the rostral stimuli on the right claw in a and b was central. If this was so, the rapid adaptation between stimuli 5 and 7 in a and between 2 and 3 in b could have been central and true adaptation. The absence of this rapid adaptation in g suggests that here again, with only the opener motor axon intact in the merus, the general stimuli excited the opener motor axon directly, a supposition supported by the similar rates of fatigue in the response to general and those to the direct stimuli.

#### 6.33 "Reflex inhibition" with general rostral stimulation.

Fig. 37 shows records of the response of a right claw to combinations of general rostral stimuli and direct stimuli to the distal transected end of the opener excitor axon. The effect of a general rostral stimulus applied during contractions maintained by direct axon stimulation varied in this preparation. In a( $\bar{1}$  and  $\bar{2}$ ), the effect was only inhibitory; in a( $\bar{3}$ ) it was at first, during general stimulus 12, to enhance the contraction; then, during general stimuli 13 and 14, it became slightly inhibitory; and in b it was again only inhibitory.

At first sight this might appear to have been an example of reflex inhibition via the inhibitory axons, at least in a( $\bar{1}$  and  $\bar{2}$ ) and b

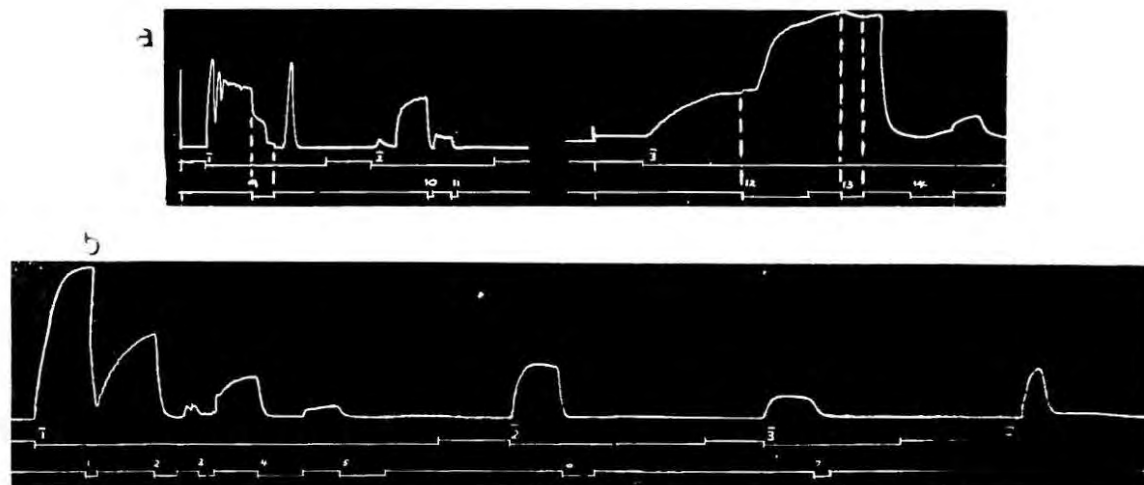

Fig. 37.

Inhibition of opener contractions, evoked by opener motor axon stimulation, by general rostral stimulation. Closer tendon cut. Opener motor axon cut and stimulated peripherally.

Stimuli : Rostral : 20 volts, 100 c.p.s., 5 msec.

Motor : 0.1 volts, 100 c.p.s., 1.5 msec.

Time : same scale as in fig. 35.

However the response shown in  $\underline{a}(\bar{3})$ , and also observations made in previous sections of the effects both of these general rostral stimuli (section 6.2) and the localized rostral stimuli with the opener motor axon cut (section 6.1), cast doubt on this interpretation.

A more reasonable interpretation may be arrived at if it is assumed that the rostral stimulation of 20 volts used in obtaining these records had both a general and a localized central nervous excitatory effect. In this case the inhibitory effect of the general rostral stimuli in  $\underline{a}(\bar{1}$  and  $\bar{2})$  and  $\underline{b}$  could have been a result of direct excitation of the opener inhibitor axons by the general stimuli. On the other hand the enhancement of the opener contraction in  $\underline{a}(\bar{3})$  could have been due to cerebral ganglion excitation resulting in an effect similar to that described in section 6.3, fig. 34, where localized rostral stimulation of 10 volts amplitude cause enhancement of opener contraction.

The following effects in fig. 37 might well be after-effects of a "central inhibitory state" resulting from the rostral stimulation: the sudden relaxation of the opener contraction, twice after stimulus 9 and after stimulus 10; the failure of the opener to regain tension after stimuli 11 and 5 - 8; and the slow or faltering and sometimes small build-up of opener tension after all other general stimuli compared to the tension build-up in response to both stimuli 1. The sudden sharp rise during stimuli 1, 2 (in  $\underline{a}$ ), and  $\bar{4}$  in  $\underline{b}$ , may furthermore have been due to release from a central inhibitory state.

Finally, it must be realized that this is only a very tentative interpretation of the main effects shown in fig. 37. This interpretation is intended only as a more tenable interpretation than the at present

unwarranted conclusion that the effects were due at least in part, to reflex inhibition via the inhibitory axons. It is not, however, intended to preclude the possibility of such reflex inhibition having been a factor involved.

#### 6.4 LOCALISED ELECTRICAL ABDOMINAL STIMULATION.

The sensory nerves of the abdomen are extremely small and difficult to isolate. If the thin soft integument covering the central portion of the ventral (inside) surface of the basal segments of the opened abdomen is carefully removed and the underlying segmental musculature is carefully dissected apart, the basal portions of the abdominal sensory nerves can be exposed. The paired abdominal nerve trunk runs ventrally from the thoracic ganglia to the base of the abdomen, where it fans outwards into the various regions of the abdomen, so that there is no main abdominal nerve running mid-ventrally in the abdomen. Most of these abdominal sensory nerves may be picked up and stimulated on the small hook electrode used for stimulating single motor axons in the cheliped.

A number of attempts were made to evoke reflex opening of the claws by electrical stimulation of the abdominal sensory axons. In a number of cases the two electrodes were simply inserted ventrally through the soft integument into the nerves and muscles in the central region at the base of the abdomen. In three experiments these abdominal sensory nerves were exposed and stimulated directly as described in the previous paragraph. Various positions of the two electrodes were tried, with the electrodes at varying distances apart. Amplitudes of 0.05 - 10 volts

were used for the direct stimulation, and of 0.05 to 50 volts for the indirect stimulation.

In none of these experiments was it possible to evoke any reflex opening response at all. This seems odd, but it may be that, in the direct nerve stimulation experiments, the handling of the sensory nerve fibres was too rough for the very delicate and fine fibres, and/or that a general electrical stimulus to all the abdominal nerve fibres as was given here excited a large number of reflex systems and this overrode the effect on the claw opening reflex. Once or twice, however, voltages of 30 to 50 volts applied ventrally with an electrode on either side of the rectus in the base of the abdomen evoked a slight erratic opening response. This however, was probably due to undefinable general nervous stimulation.

Electrical stimulation with the two electrodes in various places on the abdomen was not a very successful method of evoking claw opening. The method was extensively explored in the earlier stages of the work, but was subsequently used very little. In these early stages it was commonly used on animals in which titillator stimulation had been partly or wholly unsuccessful in evoking reflex opening. The behaviour in response to stimulation of many of these animals suggested that titillator stimulation had been unsuccessful because of some form of central inhibition operating: probably cerebral, the cerebral ganglion having been intact in all the early experiments. Furthermore, the high voltages (30 - 50 volts) which were usually necessary to evoke any claw opening response at all with abdominal stimulation indicated that the claw opening responses were probably not reflex, but were more likely due to a general stimulatory effect. This idea further supported by the fact

that high voltage abdominal stimulation usually caused evasive movements of the walking legs, which was not the case with light titillator stimulation, although it sometimes occurred with heavy titillator stimulation.

Fig. 38 is a record of claw opening responses to "localized" electrical abdominal stimulation with two electrodes 5 mm. apart on the inside surface of the last abdominal segment. The closer tendons were both out. A voltage of at least about 40 volts was required to evoke any opening response at all, at any frequency, and the high pulse duration was also necessary. The following points are of interest :

1. The left claw responded clearly only to the second 40 volt stimulus. It responded very slightly to the following five 40 volt stimuli, and then responded no more. The almost complete absence of recorded response might have been due to motor fatigue, since this record was made after five records of responses to mechanical stimulation; or it might have been due to strong central inhibition. Central or, for that matter, peripheral inhibition could conceivably have been caused in one claw and not the other by the transverse polarity produced by anode and cathode being on either side of the rectus. Some form of inhibition seems more likely than motor fatigue, since left and right claws were responding more or less equally to abdomen-pinching stimuli applied 15 minutes previously.

2. A build-up of excitation, presumably centrally, over responses 1 - 5 was apparently necessary before a large response could be evoked (response 5).

3. Responses 5, 7, 11, and 13 all developed approximately the same height and then fatigued rapidly. This looks like blocking of central

Figs. 38-40.

Claw opening responses to abdominal electrical stimulation.

Opener axons all intact.

Closer tendons intact in figs. 39 and 40a; cut in figs. 38 and 40b.

Light recording lever springs.

Stimulating electrodes 3-5 mm. apart on various regions of the soft inside surface of the last two abdominal segments.

Stimulus : 40 volts, 100 c.p.s., 4 msec., except where otherwise indicated in fig. 38.

Time : 5 seconds.

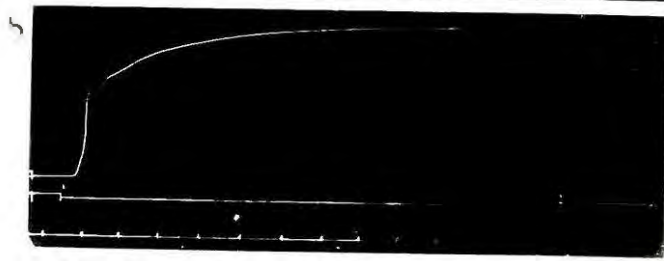
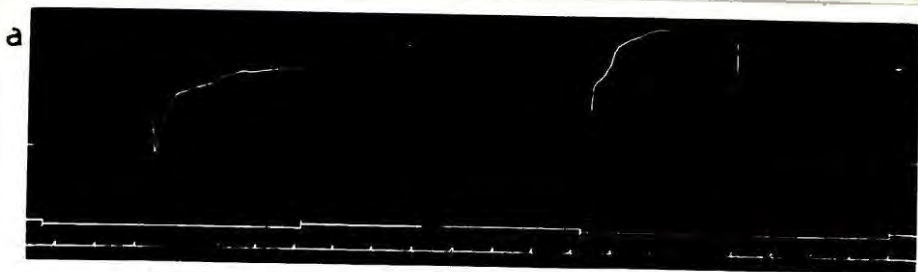
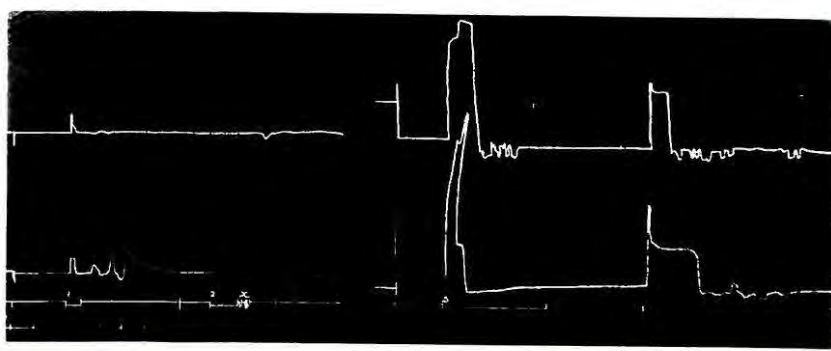
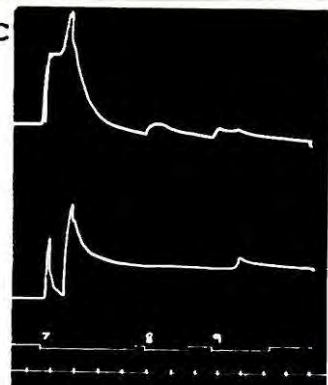
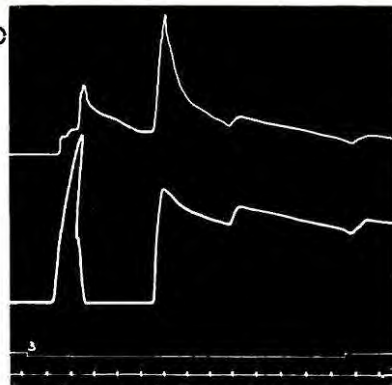

synaptic transmission by central inhibition which acts only at certain inherently determined levels - an effect which recalls the "stepwise" inhibition effect of fig. 21 g.

4. The responses are all fairly smooth and slow, suggesting a gradual spread of electrical excitation from the stimulating electrodes.

5. The absence of a response to stimulus 13 at increased pulse frequency (250 c.a.s) suggests central synaptic or motor fatigue, and is reminiscent of Welensky inhibition.

6. The complete absence of response after response 14 suggests strong central inhibition.

The whole picture appears to be one of response to spreading electrical excitation, which might have acted at almost any point on the claw opening reflex system, including possibly directly on the muscle, considering the high voltages of stimulation. The following observations from records of other experiments are in favour of spread of electrical potential from the electrodes on the abdomen.

1. Very often there was a long latent period after commencement of an electrical stimulation of the abdomen during which there was no response, then the claws began gradually to open (fig. 39 a and b). This might be a result of initial central inhibition followed by a gradual build-up of excitation, probably central to a threshold level at which opening occurs.

2. On a number of occasions "localised" electrical abdominal stimuli caused cleavage opening as an initial response, followed during the same stimulation by strong closure (b, c, and d).

This closure was then sometimes followed up by clearcut opening (a, b, and c) or erratic opening and closing (d). This looked like an effect of fairly general central excitation by the electrical stimulus.

3. Sometimes the initial opening response itself was followed immediately by erratic alternate opening and closing (e). This occurred even with very light recording lever springs, so that since the closures were sharp movements it was not due simply to alternating contractions and relaxations of the opener, but to active contractions of both opener and closer, the closer tendons being intact. Clearly this indicates active excitation of the closer motor system, for instance by the electrical potential. That active excitation of the closer motor system does occur in these circumstances is shown in fig. 45 of records before and after cutting of the closer tendon. After cutting there was no sharp closing during a long stimulation as there was before cutting.

4. In one experiment the soft ventral integument at the base of the abdomen was split transversely between two segments and the underlying nerves were severed between abdomen and thorax. Titillator or pinching stimuli to the abdomen of low or high intensities then failed to produce any clawopening response at all, as was to be expected. However, light stroking of the sternal plate caused clean slow claw opening. Electrical stimuli of 40 volts were then applied with two electrodes 5 mm. apart on the inside surface of the last segment of the abdomen causing, after a short initial delay period a fairly clearcut opening response in both claws. This is a clear indication of the spread of the electrical stimulatory current at least beyond the base of the abdomen. Unfortunately

no kymographic record of this experiment was obtained.

5. The erratic effects of regularly repeated electrical stimuli of the abdomen, including erratic after-discharge effects of individual stimuli, make it quite clear that central influence is involved. The records shown in fig. 41 are fairly typical. The "step" effects in records 1 and 2 suggest build-up of a central excitatory state. When the claw closer tendon was not cut, as in fig. 42 opener muscle contraction, after the first sharp opening response of a series, was dominated by, presumably, closer excitation.

6. The left claw opening responses to repeated electrical stimulation of the abdomen before and after transection of the specific opener inhibitor axon shown in fig. 42 suggests some active role of this inhibitor axon, since after inhibitor transection four successive opening responses were obtained, whereas before only two successive responses were obtained. However this superficial observation is deceptive. All the large claw opening responses shown in fig. 43, except claw response 1 and right claw responses 1 and 13, commenced on cessation of the electrical abdominal stimulus. The absence of an opening response during each of these stimuli was clearly due to some form of inhibition. Since it happened even after transection of the specific opener inhibitor in the left claw, it was not due to neuro-muscular junctional inhibition by the specific opener inhibitor, unless the stimuli acted directly on the distal portion of the opener inhibitor, which is unlikely. It was probably not due to NMJ inhibition by the common inhibitor, since this was unlikely to have caused such complete inhibition. Furthermore, the opener contraction

Figs. 41-43.

Claw opening responses to repeated abdominal electrical stimulation.

Opener axons all intact; except in fig. 43b, in which the specific opener inhibitor axon was cut.

Closer tendons intact in figs. 41 and 43, cut in left claw only in fig. 42.

Light recording lever springs in all; except fig. 43, in which heavier springs were used.

Stimulating electrodes 3-5 mm. apart on various regions of the soft inside surface of the last two abdominal segments.

Stimulus : 40-50 volts, 100 c.p.s., 4-5 msec.

Time : 5 seconds.

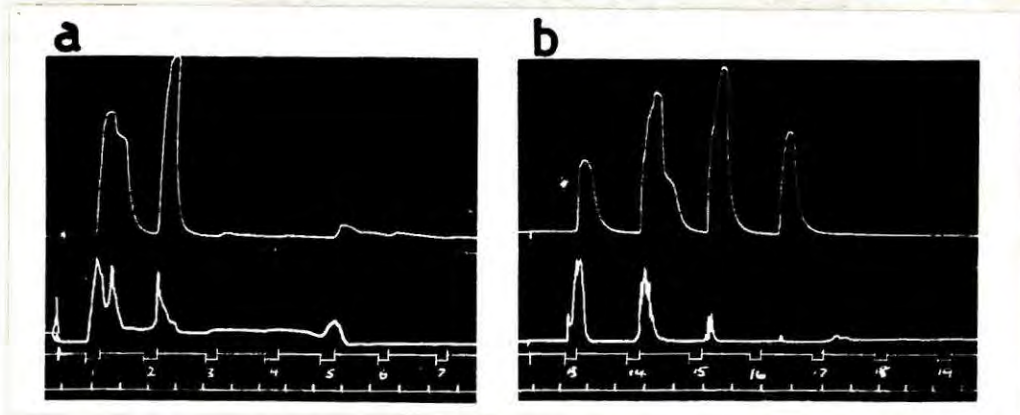
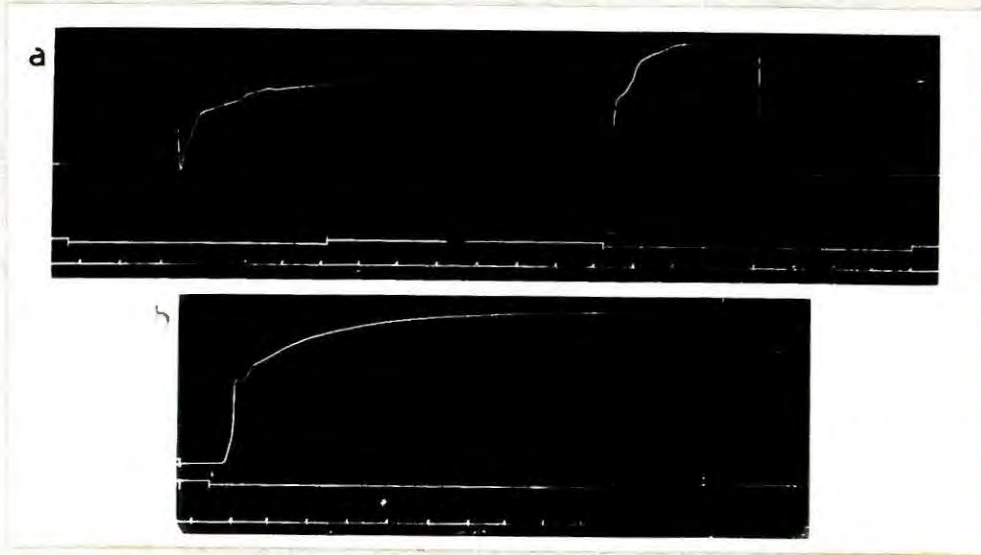
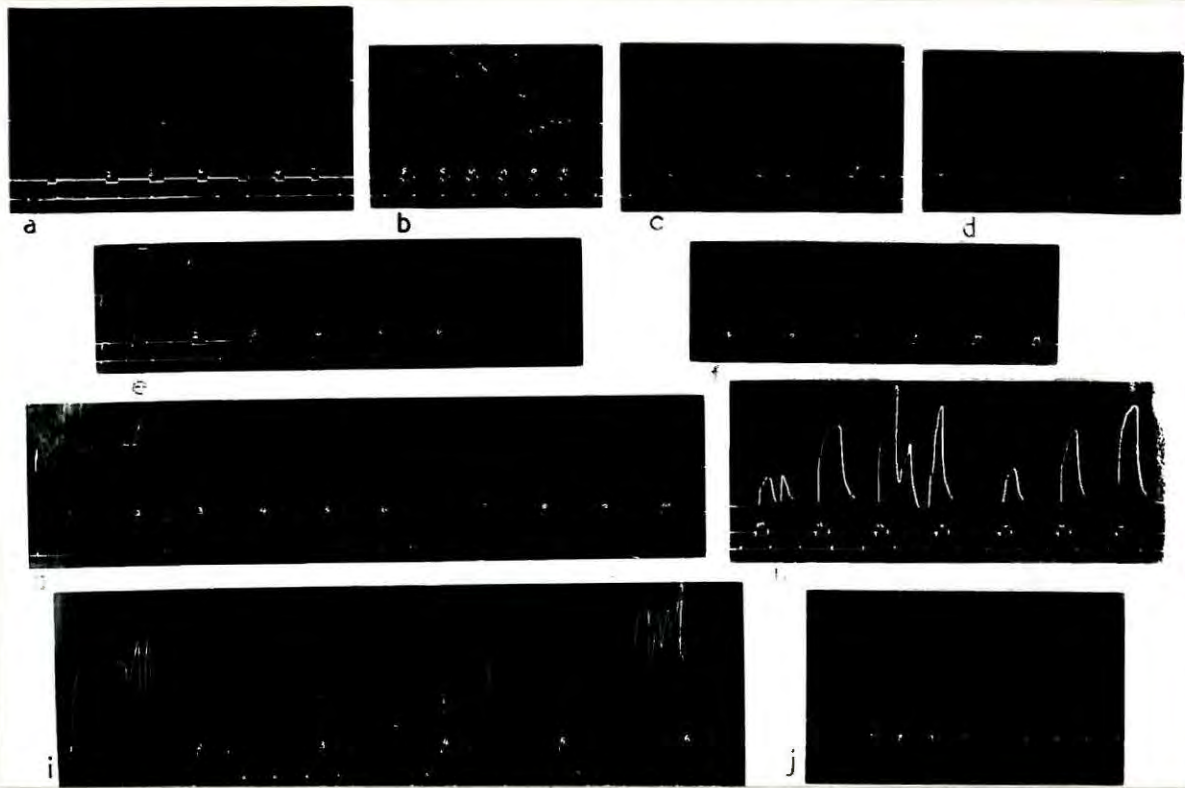

immediately on cessation of the stimulus suggests central release from the inhibition which acted during the stimulus. It thus seems that the positive inhibition during the stimuli was central. At any rate it was independent of the common inhibitor and probably also of the specific opener inhibitor. Clearly this is suggestive, albeit not critical, evidence in favour of central inhibition rather than NMF opener inhibitor axon inhibition being involved in the inhibition effecting adaptation to abdominal sensory stimulation.

All this evidence in favour of the general effect of high voltage electrical abdominal stimulation makes it clear that there was no point in continuing with this form of "sensory" stimulation to evoke reflex claw opening.

## 6.5 CONCLUSION.

The high voltages usually necessary to evoke claw opening and the diversity of effects occurring in the mechanical claw opening responses indicated that the claw opening responses to the electrical stimulation used in this work were not reflex responses at all, but were responses to unspecific stimulation of diverse elements of the nervous system. This was true for the three forms of electrical stimulation used in this work, namely abdominal, "localized" rostral and "general" rostral stimulation. Certain other effects were obtained only in one or two of these three forms.

### 1. Abdominal Stimulation.

From the experimental observations made in section 8.4 it was concluded that, with electrical abdominal stimulation, there was a spread of electrical potential, from the point of stimulation on the abdomen, to beyond the base of the abdomen, and this potential caused fairly general stimulation of the nervous system. Thus, when the closer tendon of the claw was intact, sharp closing frequently followed the initial opening; this closure was often followed by erratic alternate opening and closing. When the closer tendon was cut, closure usually did not follow the initial opening (fig. 40), although sometimes it did, such closure being attributed to central inhibition of opener tension (fig. 38). Clear evidence for central inhibition was seen in the post-stimulus responses of fig. 43, which occurred even after the opener inhibitor axon had been cut. This indicates the possibility that all the post-stimulus responses in this work were after-effects of central inhibition. Certain effects of electrical abdominal stimulation were almost certainly due to central excitatory influence: build-up of

response strength with repeated stimuli, the increasing responses being either separated or connected in the form of steps; maintenance of opener contraction between stimuli, sometimes with small additional responses at each stimulus; erratic inter-stimulus openings and closings, with sometimes even a build-up of a strong response between stimuli (fig. 41).

In the light of these conclusions, it is of interest to consider Hoffmann's experiments on Astacus, in which he stimulated the abdomen ventrally with an electrode on either side of the nerve cord. The only published trace from such an experiment was one obtained from one cheliped with opener motor axon transected, and stimulated regularly at more frequent intervals than the electrical abdominal sensory stimuli. The opener contractions following the abdominal stimuli were smaller than the ensuing opener contractions (fig. 26). Hoffmann claimed this to be a result of reflex inhibition via the opener inhibitor axon.

Hoffmann does not give the voltages of the induction coil stimuli which he used, but simply gives the relative potentials on an arbitrary scale of units. However, it is possible from the units given to estimate very approximately the voltages used, by comparison with voltages used in the present experiments on Potamon and in experiments by other workers on other Decapod species. Hoffmann states that it was usually possible to evoke claw opening by a stimulus of 25 to 30 units to the "thin" cheliped nerve. Wiersma (1933) used rectangular wave repetitive pulse stimuli of 1-6 volts intensity applied to the thick or thin cheliped nerve in Astacus fluviatilis, to evoke closing or opening, respectively, of the claw. Fantin (1934) found that an

alternating current stimulus of 1 - 125 volts to the cheliped nerve of Garcinus sp. evoked claw opening. In the present experiments on Potamon, 1 - 2 volts applied to the whole nerve evoked claw opening with the closer tendon severed. From these figures it is reasonable to assume that Hoffmann's stimuli of 25 units to the thin cheliped nerve were of 1 - 2 volts, in which case the stimuli of 400 units to the ventral nerve cord were 16 - 32 volts. In the present experiments on Potamon, a stimulus of 20 - 30 volts to the abdomen was usually adequate to evoke claw opening, which, as has been concluded, was a response to general unspecific stimulation of the nervous system. It is therefore possible that the suppression of the opener contractions in response to direct motor stimulation, shown in the record published by Hoffmann (fig. 28), were due to central inhibition, or even direct excitation of the opener inhibitor axon, caused by the electrical stimulation to the abdominal ventral nerve cord. If this were so, then clearly the suppression was not due to reflex inhibition via the opener inhibitor axon, as maintained by Hoffmann. However, even if this were so it would still be possible that reflex inhibition via the opener inhibitor axon of opener contraction does occur in response to mechanical stimulation of the tail, though not to the electrical stimulation used in this instance by Hoffmann. But this seems unlikely since Hoffmann published only this one kymographic record showing "reflex inhibition", so that it may be assumed to be a typical record of such an effect.

At any rate, the present observation throws doubt on Hoffmann's conclusion, that the inhibition of claw opening in Astacus fluviatilis

produced by sensory stimulation of the tail is effected by reflex inhibition via the opener inhibitor axon. This, in turn, makes it questionable whether the adaptation of reflex claw opening observed by Hoffmann was, in fact, effected by reflex inhibition via the opener inhibitor axon. Clearly, it is necessary to repeat the experiment from which Hoffmann obtained the record reproduced in fig. 28, preferably with Astacus fluviatilis, using a more clearly definable sensory stimulus to the abdomen.

2. "Localised rostral stimulation".

It is clear from the results of the experiments in section 6.3, that localised rostral stimulation also caused claw opening by its unspecific stimulatory effect, and not by reflex excitation. This is shown, inter alia by a comparison of the effects, or absence of effects, of titillator stimulation, and the effects of rostral stimulation (e.g. fig. 31). The effects of localised rostral stimulation are divisible into groups: general stimulatory effects, which resulted from the high voltage stimulation (35 - 50 volts), which was usually required to evoke any opening responses at all; and differential stimulatory effects, which occasionally resulted from low voltage stimulation (10 - 20 volts), but sometimes, under certain experimental conditions, from high voltage stimulation (e.g. fig. 31 - 30 volts). The former effects were in some ways similar to those of abdominal stimulation, and showed clear signs of a fairly general stimulatory effect on the nervous system (figs. 32, 33): delayed responses, and sharp closure during stimuli, due to closer antagonism or central inhibition; erratic opening and closing, due to opener-closer antagonism; "stepwise" build-up of response height, due presumably

to central excitation build-up; successive responses of similar heights.

The occasional appearance of clearcut opening responses with lower voltage stimulation can be attributed to differential excitation of the opener motor and inhibitor axons caused by a direct stimulatory effect by the electrical potential on the cheliped ganglion. In fig. 31, the dominant motor excitation is attributable to the specific opener and common inhibitor axons having been transected; in fig. 23, with lower voltage stimulation (10 volts, c.f. 30 volts in fig. 31), it may have been an effect of differences in the central synaptic thresholds.

The opening responses to low voltages occasionally showed effects which could readily be interpreted only as being due to direct stimulation of the cerebral ganglion. Thus in fig. 23, the post-stimulus spikes occurring in the left claw but not in the right are attributed to release from inhibition of the left cheliped ganglion by the left cerebral ganglion, the left cerebral inhibition being evoked by the cathodic stimulus on the left side. This observation enhances the possibility of the similar post-stimulus spikes, following light titillator sensory stimuli (e.g. fig. 22), having been due to release from cerebral inhibition.

### 3. General rostral stimulation.

As was emphasised in section 6.2, "general rostral stimulation" had a fairly general stimulatory effect on the nervous system. The recorded opening responses to such stimulation were usually not clearcut, due to the rather unspecific stimulation of various nervous elements, in particular of motor inhibitor axons of the opener muscle (and of the closer muscle when the closer tendon was not cut). More clearcut opening

responses were obtained when the general stimulus was localised on the opener motor axon, by holding the axon on an electrode out of the saline in the meris. An instance of what appeared to be reflex inhibition in a claw in which the opener axon had been transected, was concluded to be an effect of direct stimulation of the opener inhibitor axon.

The differential effects of the general rostral stimulation on the opener and closer muscles of the claw are of interest in relation to the effects of direct current on insect and other crustacean ganglia. Hughes (1953) found, in Pariphaneta sp., that small longitudinal direct currents applied to the metathoracic ganglion caused flexion when the head was towards the cathode, extension when the head was towards the anode. Transverse currents across the mesothorax caused flexion of the leg on the negative side, extension of that on the positive side. Amongst the Crustacea, Palaeomonetes sp. was found by Loeb and Maxwell (1926) to react to longitudinal current stimulation, with the head towards the cathode, by flexion of the abdomen and fifth limb pair, and extension of the third limb pair; with reversed current, it reacted with the opposite effects; with stronger currents, all the muscles were excited. Miller (1907), working on a crayfish, and Scheminsky (1943) on many invertebrate species, found that strong longitudinal current, with cathode towards the head, caused activation of all the muscles, whereas strong currents in the opposite direction caused depression or paralysis of activity. All these workers considered these effects to have been produced by stimulation of the central nervous system, and Miller considered that direct stimulation of the motor axons was also involved. Loeb and Maxwell suggested

that the cell bodies of the flexor and extensor motor neurones were differently oriented in the ganglia, while Hughes considered that the internuncial neurones connecting neuropile regions of flexor and extensor synaptic endings were specifically oriented within the ganglion, and suggested that the current produced its differential effects by influencing the existing gradient of potential along these internuncial neurones.

In the present work on Potamon, square-wave repetitive pulse stimuli of 10 - 15 volts, with the cathode on the rostrum and the anode on the last abdominal segment, caused opening (i.e. extension of the dactylus) in both claws. The same stimulus, with anode and cathode reversed, evoked no response from the claws. With the cathode on the rostrum, the left claw closed when the anode was placed in the socket of its own coxus, but opened when the anode was placed in the socket of the right coxus; and conversely with the right claw. That is, considering this stimulus as a transverse one, closing (flexion) occurs on the positive side and opening (extension) on the more negative side. These effects are the opposite to those observed by Hughes in Parinlaneta. However, they are not strictly comparable, since Hughes was working on isolated metathoracic preparations. It is nevertheless conceivable, though unlikely, that the opposite effects in Potamon are due simply to the presence of the intact cerebral ganglion in the crabs, this exerting reciprocating inhibitory effect on the "flexor-extensor balance" (c.f. Hughes) of the limbs. However, the effects observed in the claw of Potamon are similar to the effects of strong longitudinal current

stimulation observed by Miller and Scheminsky, in that stimulation with the cathode on the rostrum activated the opener or closer muscle, while with the anode on the rostrum stimulation evoked no response from any limb. Furthermore, it has already been concluded that general rostral stimulation in Potamon in addition to its effect on the central nervous system, had a direct stimulatory effect on the claw opener and closer axons. Thus, comparison of these observations on Potamon with those of other workers on other species, lends further support to the conception of the general and differential effects of the general rostral stimulation used in the present work.

135.

## 7.0 CEREBRAL GANGLION ELIMINATION.

### 7.1 INTRODUCTION.

There were two main reasons for attempting to eliminate the cerebral ganglion ("brain") in the present experiments. The first was that it was impossible that cerebral inhibition was causing the disappearance of the claw opening reflex, during the cheliped dissection and opener axon separation process, which frequently occurred at one stage of the present work (see section 4.5(3)). The second was that it was possible that cerebral ganglion influence was to a certain extent complicating and obscuring the main phenomena of the adaptation of reflex claw opening. It was therefore decided to eliminate the cerebral ganglion surgically before starting any experiment on reflex claw opening.

The brain lies immediately beneath the hard exoskeleton in the small region between the rostral protuberance and the anterodorsal "lip" of the mouth. The two circumoesophageal commissures leave the brain separately in its postero-ventral aspect, and diverge slightly around the oesophagus, close beneath the exoskeleton, and then converge again and run, in parallel, away from the exoskeleton and straight to the suboesophageal ganglion, which is fused into the thoracic ganglion mass.

The brain could be eliminated either by destroying it completely, or by transecting both circumoesophageal commissures. The latter proved to be <sup>the</sup> less difficult and more suitable method. The method has been briefly outlined in section 4.5 (3). Only a few preliminary experiments involving cerebral ganglion elimination have

been done, and the following observations are drawn from these experiments.

## 7.2 EFFECTS OF CEREBRAL GANGLION ELIMINATION ON THE CLAW OPENING REFLEX.

Only two experiments yielded information as to whether brain elimination prevents the disappearance of the claw opening reflex occurring during the dissection process. In the first of these, the claw opening reflex was still normal when the experiment was commenced 9 hours after transection of both circumoesophageal commissures. However, with each claw, the opening reflex decreased slightly on removal of the flexor muscle, and disappeared completely on separation of its opener axons. Clearly in this crab, brain elimination had little effect in preventing the loss of the claw opening reflexes.

In the second of these experiments, in which the right circumoesophageal commissure only was transected, the opening reflex of the left claw did not decrease in strength at all during removal of the left cheliped flexor and extensor muscles. It is possible, but improbable, that this was a result of the transection. Although, in some insects, at least, one half of the cerebral ganglion does have an inhibitory influence on the contralateral thoracic ganglia, the main inhibitory influence of the cerebral ganglion is on the ipsilateral thoracic ganglia. (Boeder, 1953).

During the dissection of the right claw merus in the present experiment, the abnormally placed opener motor axon was accidentally stretched and severed in the merus. Approximately at this time the <sup>claw</sup> opening reflex ~~claw~~ disappeared, but reappeared again after 10 minutes. This rather

looks like an effect of depression of the excitatory state of the cheliped ganglion, by antidromic impulses set up in the opener motor axon of the right claw by the act of stretching and severing it. A similar effect, of suppression of the contralateral claw opening reflex, was not observed in any other experiment.

Clearly the results of these two experiments are not critical. Further experiments, with bilateral and unilateral commissure transection, are required to answer the question as to whether brain elimination affects the disappearance of the claw opening reflex during dissection.

In one experiment only was a record of reflex claw opening response obtained after transection of a commissure, in this case unilateral commissure transection, with contralateral claw recording. All axons of the claw intact, but the closer tendon was cut. The adaptation of reflex opening responses to repeated light titillator stimuli was rapid, clearcut and hyperbolic. This clearcut adaptation might have been due to contralateral commissure transection, but it is doubtful. In another experiment with similar conditions of stimulation and recording, neither commissure was transected, but the crab was cooled before the experiment, two hours before recording reflex claw opening responses of the left claw only. The adaptation of these responses to repeated stimuli was very similar to that of the previously described experiment. On the other hand, the adaptations of the reflex opening responses of both the left and the right claw to repeated stimuli in a crab which was not cooled, and in which neither commissure was transected, but in which similar conditions of stimulation and recording were used, showed

definite indications of central build-up of excitation (see fig. 23, responses 5 - 8). It may be that cooling and contralateral commissure transection had the same effect in eliminating such a build-up of central excitation, but it is unlikely that such an effect of cooling would be still manifested two hours after cooling. Clearly further experiments to test the effects of cerebral ganglion elimination on the adaptation of reflex claw opening are required.

### 7.3 EFFECTS OF CEREBRAL GANGLION ELIMINATION ON LOCOMOTOR ACTIVITY.

Immediately on transection of one or both circumoesophageal commissures, in all five of the experiments in which this was done, the walking legs of the ipsilateral side or of both sides, respectively, reacted violently by strong alternate flexions and extensions of all their joints. This undoubtedly was a result of strong central transection. However, for 15 - 20 minutes after transection the walking legs were markedly more active than they were before transection, and with unilateral transection the ipsilateral legs were somewhat more active than the contralateral legs. Moreover, the reflex responses of the leg(s) on the operated side(s) were more excitable, for the first 15 - 20 minutes after transection, than they had been before transection. Thereafter, the legs became gradually partially flexed, and remained thus.

When, in each of two experiments in which both commissures had been transected, the crab was shortly afterwards removed from the preparation board and placed right way up on the table, the walking legs initially reacted for a short period, by apparently unco-ordinated

forward "stepping" activity, this resulting in slight, unsteady forward progression. They then became partially flexed, so that the body was held somewhat raised off the surface, the facial surface resting on the flexed chelipeds and the posterior end raised up. This position was maintained except for occasional short periods of slight stepping activity in response to prodding the animal, until death. This condition recalls the condition known as "decerebrate rigidity" in mammals, in which tonicity is developed and maintained in the extensor limb muscles (Creed, Denny-Brown, et al., 1938), and a similar condition in the cockroach, in which tonicity of the depressor limb muscles is maintained by hyperactivity of the "slow" motor nerve fibres (Pringle, 1940). In the crabs, however, tonicity is maintained in the flexor limb muscles. The three conditions are comparable in that they all result in maintenance of standing posture.

In two experiments in which only the right commissure was transected, the right walking legs reacted more actively than the left ones, when the animal was first placed on the table, and again when the animal was prodded. This greater activity in the right walking legs resulted in anti-clockwise rotation or "circus movements". In one of these crabs, the left commissure was subsequently transected, by dissection from the dorsal surface. Thereafter there was no difference in activity between left and right walking legs, and further short periods of activity did not result in circus movements.

Similar differences in locomotor activity between the legs of the two sides of the body after unilateral cerebral ganglion elimination, with greater activity on the operated side, have been recorded by various workers in various crustaceans and insects (Bethe, 1897). It is now generally accepted that the cerebral ganglion of one side in insects

has an inhibitory influence on the ipsilateral thoracic ganglia (Hoeder, 1953). It is not improbable that the cerebral ganglion in Crustacea in general, and in Potamon perlatum in particular, has a similar influence on thoracic ganglion activity.

#### 7.4 OTHER EFFECTS OF CEREBRAL GANGLION ELIMINATION.

An effect which was observed in four crabs, in which one or both circumoesophageal commissures were transected, was hyperactivity of the ipsilateral scaphognathite(s). In any normal unoperated crab, the two scaphognathites usually ceased to beat soon after removing the crab from water. After removal of each of the present crabs from water, however, the scaphognathite(s) on the side(s) on which the commissure(s) had been transected continued to beat, with occasional intermittent cessations of 5 - 10 seconds duration, until approaching death. This seems to be another manifestation of release from cerebral inhibition by commissure transection.

An odd effect was observed in one crab in which the right circumoesophageal commissure was completely transected by means of a red-hot dissecting needle, and the left commissure was apparently partially severed. Two hours after commissure transection, light stroking of the inside cutting edge of either the dactylus or the immovable ramus of either claw, which in a normal crab causes sharp reflex closing of that claw, in this case caused sharp opening of that claw. Stroking on the outside edge of either ramus of the claw, which normally causes slow opening of that claw, in this case caused slow closing of the claw.

This occurred both in the left claw, with intact closer tendon, and in the right claw, whose closer tendon was cut, though closing in response to stroking the outside edge of the claw was, naturally, in the right claw no more than indicated. As in normal crabs, there was no effect of the stroking stimulus on the contralateral claw. Furthermore, stroking, tapping or titillator stimulation of either the sternal plate or the inside surface of the abdomen caused opening of both claws, that is, the normal response to such a stimulus. All the common readily evokable walking leg reflexes also appeared to be normal. Unfortunately, these two reflexes were not tested prior to commissure transection but there is no reason to believe that they should not have been normal. In any case, the "reversal" of the two reflexes is odd, and its significance is unclear. Further experiments to explore this effect are required.

#### 7.5 CONCLUSION.

From the experiments described in this section, it is not possible to decide whether cerebral ganglion ablation does help to prevent (a) the disappearance of the claw opening reflex during the dissection and separation of the opener axons, or (b) the complicating effects of central excitatory state on the adaptation of mechanical reflex responses to light titillator sensory stimulation. The first experiment described in section 7.2, however suggests that bilateral commissure transection does not help to prevent the disappearance of the claw opening reflex. Clearly, further more comprehensive experiments are required to answer these two questions.

It seems fairly clear that each side of the cerebral ganglion has an inhibitory effect on ipsilateral locomotor and scaphognathite activity, since unilateral or bilateral transection of the circum-oesophageal commissures results in increased activity of the ipsilateral walking legs and scaphognathite(s). In this respect Potamon parvulus is in agreement with certain other Crustacea and numerous Insecta which have been studied (Reeder, 1953). The effect of each side of the cerebral ganglion on the activity of the contralateral walking legs and scaphognathite in Potamon is not clear. Here again, further experiments are required.

The significance of the reversal of the opening and closing reflexes, described in section 7.4, is also unclear. Further experiments including experiments in which one or both commissures are partially transected, are required to explore this phenomenon.

8.0 DISCUSSION.8.1 The nature of the adaptation of reflex claw opening.

The present study of adaptation and inhibition of reflex claw opening in Potamon perlatius (Milne Edwards) has indicated that these two phenomena are effected independently of peripheral neuro-muscular-junctional inhibition by the inhibitor axons innervating the opener muscle. Strong mechanical sensory stimulation of the abdomen causes sensory adaptation which in turn causes adaptation of the mechanical responses of reflex claw opening. Light mechanical sensory stimulation, on the other hand, causes what appears to be central nervous adaptation, this in its turn causing adaptation of the reflex responses. Furthermore, the "reflex" inhibition of an existing opener contraction by sensory stimulation appears to be effected largely by central inhibition, as opposed to inhibition via the opener inhibitor axons. It is possible that central inhibition of this kind is responsible for effecting the adaptation of reflex claw opening responses to repeated sensory stimuli. It must be remembered, however, that these conclusions are very tentative, owing to the paucity of the experimental evidence.

These conclusions on Potamon perlatius are in direct contrast to the conclusion of Hoffmann (1914) on Astacus fluviatilis Linn., namely that adaptation of reflex claw opening responses to prolonged or repeated sensory stimuli are effected by simple reflex inhibition via the opener inhibitor axon. Hoffmann claimed to have shown, further, that opener contraction may be reflexly inhibited via the opener inhibitor axon, by his experiments involving transection of the opener motor axon. However, it has been sho

in section 6.5(1), that this "reflex" inhibition might have been simply a result of direct stimulation of the opener inhibitor axon, due to the high voltage of electrical stimulation used. Moreover, the long after-effect of inhibition shown in Hoffmann's record (fig.28) suggests central rather than peripheral inhibition. The opener contraction in this record was still suppressed to 2/3 of its maximal height, 20 seconds after the second sensory stimulus of 4 seconds duration; and 25 seconds after the third sensory stimulus of 7 seconds duration, the opener contraction was still suppressed to 1/3 of its uninhibited value. Marmont and Wiersma (1938) showed, in Astacus trowbridgii and Cambarus clarkii, that, whereas isometric contraction of the opener muscle, in response to stimulation of the opener motor axon, was still completely suppressed 3 seconds after similar stimulation, for 3 minutes, of the opener inhibitor axon; 3 seconds after 1 minute of inhibitor axon stimulation, the contraction was only slightly suppressed; and 3 seconds after a 3-second stimulus of the inhibitor axon, the contraction was not suppressed at all. After what was presumably a long duration stimulus to the inhibitor axon, the inhibition of opener contraction thus elicited was, however, maintained for as long as 65 minutes in some preparations. It nevertheless remains unlikely that the inhibition following the short stimuli in fig.28 was due solely to neuro-muscular-functional inhibition. At all events, this in itself does not affect the validity of Hoffmann's conclusion that the adaptation of reflex claw opening in response to tactile sensory stimulation, was effected by inhibitor axon inhibition resulting from the sensory stimulation.

There appears, therefore, to be a considerable difference between Potamon and Astacus in their physiological mechanisms for effecting

adaptation of reflex claw opening to repeated sensory stimulation. In Potamon, this mechanism is apparently central, whereas in Astacus the mechanism is apparently peripheral. It is not inconceivable that this difference was due some difference in experimental conditions which was not appreciated at the time. Considering only the one critical experiment with light sensory stimulation in the present work, the only difference in experimental operation from that of Hoffmann's experiments was that the whole nerve except the opener motor axon was transected in the merus in order to transect the opener inhibitor and common inhibitor axons, whereas in Hoffmann's experiments the thick nerve was transected in the carpus, thus leaving the closer-stretcher inhibitor axon and a few bundles of sensory axons intact as well as the opener motor axon. The intact closer-stretcher inhibitor could not have had any effect, since the closer tendons were cut; and it is unlikely that the intact sensory axons had any effect on the reflex responses. Thus the experimental conditions were comparable in all relevant respects.

However, owing to the paucity of the experimental evidence, it still remains possible that this difference is not, in fact, valid: if, for instance, the few results of the experiments on Potamon, or of those on Astacus, are not typical. Clearly, only further experiments can answer this question. Nevertheless, for the discussion following, the main conclusions of the present work on Potamon, and of Hoffmann's experiments on Astacus, as to the nature of the adaptation of reflex claw opening, will be assumed to be valid.

## 8.2 A possible basis for the difference between Potamon and Astacus.

Assuming the conclusion of Hoffmann to be valid, that adaptation of reflex claw opening in Astacus is effected by reflex inhibition via the opener inhibitor axon, and assuming the conclusion of the present work also to be valid, that the same adaptation in Potamon is effected centrally, with light sensory stimuli, then this difference between Astacus and Potamon must be explained.

In the first place, some anatomical or functional basis for the difference might be found in a comparison of the axon innervation patterns. Since the motor axon innervations of the Astacura and Brachyura are anatomically identical, and the opener motor axons functionally not dissimilar, there can be no basis for the difference in the motor axons. Furthermore, it is improbable that the R<sub>c</sub> values of the opener inhibitor axons of Astacus and Potamon differ sufficiently for this to be a basis for the difference. Since it appears, from one experiment, that transection of the common inhibitor axon, as well as the specific opener inhibitor axon, does not affect the reflex claw opening responses or their adaptation, the presence of the common inhibitor in Potamon and not in Astacus is also not a basis for the difference. Assuming that the opener inhibitor axon in Potamon, as in the Brachyura studied by Wiersma (1941), innervates also the flexor muscle, this might constitute a disadvantage if opening adaptation were to be effected by peripheral inhibition, since peripheral inhibition would occur in the flexor simultaneously with that in the opener. However, such inhibition could in all probability be dominated by the quadruple motor innervation of the flexor. There is thus no basis for the apparent

difference between Astacus and Potamon, in the anatomical or functional characters of their innervation patterns.

It therefore becomes necessary to seek the basis for the difference between Astacus and Potamon in the central nervous system. It has been concluded that the adaptation of reflex claw opening in Potamon is effected by adaptation at the central synapses of the opener motor axon. This, it was suggested, might be effected by progressive blocking of these synapses by central inhibition.

Some observations on intact crabs are of interest here in suggesting central inhibition of reflex activity. When an animal was suspended upright by a pencil glued on to the top of the carapace, light stroking of the sternal plate usually caused claw opening, and in addition, flexion and bending of the chelipeds. The three components of this reflex response adapted together, and eventually ceased to respond, if the stroking was repeated a number of times. Stroking on another spot which usually evoked a similar response, for instance, the flat antero-ventral surface of the cheliped merus, did not then evoke a response, so that the adaptation was apparently not sensory. However, stroking on the antero-dorsal face of the propus as usual, caused extension and stretching of the chelipeds, and subsequent stroking on the sternal plate evoked the opening, flexion and stretching response again. Apparently, the excitation of a different reflex had the effect of restoring central excitatory state, which had been abolished or at least dominated by central inhibition which resulted from the repeated stroking of the sternal plate.

On the other hand, in Astacus, since transection of the opener inhibitor axon apparently abolished the adaptation of reflex claw opening

responses to repeated sensory stimuli, it is possible that this adaptation is effected entirely peripherally; that is, if each successive similar stimulus evokes a similar degree of activity in the opener motor axon, and also in the opener inhibitor axon. It is also possible, however, that it is effected centrally, by increasing activity in the opener inhibitor axon with repeated stimuli. Such increasing opener inhibitor activity might conceivably be effected by a slow process of facilitation of the central synapses of the opener inhibitor axon, this in turn, perhaps, being determined by an increasing central excitatory state acting on these synapses. If, in fact, the reflex adaptation in Potamon is effected centrally, as postulated, then it would seem more likely that the adaptation in Astacus is also effected centrally, rather than peripherally. The mechanism suggested above, of increasing activity in the opener inhibitor axon, would therefore seem the more likely of the two alternatives, and would also explain the difference between Astacus and Potamon.

### 8.3 Behavioural significance of the difference between Potamon and Astacus.

In Potamon the combined reflex of opening, bending, and flexing appears to be primarily defensive in character. This could well have been the primitive function of such a reflex complex. With this function it would be disadvantageous for the responses to be too stereotyped and inflexible, and centrally controlled adaptation clearly has greater potentialities for flexibility than has peripheral inhibitory adaptation. Further information is required on the relation of the claw opening reflex in Astacus to its behaviour to suggest a behavioural function for it. It is difficult to see how the reflex opening response of the claw to stimulation of the abdomen could be defensive in Astacus, unless it is part of a reflex complex which involves turning round to face the stimulus. At any rate, since the abdomen

is probably frequently stimulated in the normal life of the animal, for instance when the animal retreats backwards into a rocky crevice, it would seem preferable for the animal to be able to adapt the response somewhat more rapidly and "automatically" than were it dependent upon some variable form of control, such as inhibitory blocking of synaptic conduction. The mechanism suggested above, of a slow facilitation of the central synapses of the opener inhibitor axon, might be an answer to this requirement.

In relation to these possibilities, it would be of interest to compare reflex claw opening in the Anomura, both in the hermit crabs, whose abdomens fit into their gastropod shells, and in the porcellanid crabs, whose abdomen is completely reduced like that of the Brachyura. It is most improbable that both the Astacus and the Potamon types of reflex claw opening adaptation are present in the one tribe. A study of the Anomuran adaptation would also be of interest in relation to the different innervation pattern, in particular since the Anomura have both a common inhibitor and a specific opener inhibitor axon which innervates no other muscle in the limb (Wiersma and Ripley, 1952).

#### 8.4 Mechanism of reflex responses and their adaptation in Decapod Crustacea.

The hypothesis suggested in section 8.2 for the mechanisms of adaptation of reflex claw opening in Potamon and Astacus is clearly very tentative, as has been emphasized. Extensive experiments are required to test this hypothesis, and to elucidate further the mechanisms involved. As indicated in section 5.10(1), experiments in which electrical activity is recorded in the motor, central, and sensory elements of the claw opening reflex arc, would be of particular value in this respect. It would, for instance, be possible to decide whether the adaptation in Astacus was a true peripheral adaptation; if this were so, there would be little if any increase in inhibitor activity, or decrease in motor

activity, with repeated stimuli; if either one or both of these response variations did occur, this would imply central control of the adaptation, as postulated.

Apart from the experiments of Hoffmann (1914), there is no recorded experimental evidence on the mechanism of any reflexes in the Crustacea. Prosser (1935) found in the crayfish that tactile or proprioceptive stimulation of the antennae, uropods, chelipeds, and walking legs, elicited electrical activity in the circumoesophageal commissures and in the nerves of the walking legs. Amongst the insects, Pringle<sup>(1940)</sup> found in the cockroach that the frequency of electrical discharge in the depressor trochanteris muscle in response to strong proprioceptive stimulation declined, with continued stimulation, at a rate closely corresponding to the adaptation rate of the trochanteral campaniform sensilla, so that the reflex adaptation in this case was clearly due to sensory adaptation. This recalls the adaptation of reflex claw opening in response to heavy mechanical sensory stimulation in Potamon. Pringle also found, during a reflex response of the depressor trochanteris muscle, that whereas in this muscle the frequency of the electrical discharge was greater than the frequency of the normal resting "background" discharge, in the antagonistic levator tibiae muscle the frequency of discharge was lower than its normal background frequency, or was even reduced to zero. During reflex contraction of the levator tibiae muscle, the electrical discharge frequency in the two muscles varied from the norm in the opposite sense. That is, these two antagonistic reflexes are reciprocally inhibited. Since no nerve fibres having an inhibitory effect on muscular activity have been found in the Insecta, this reciprocal inhibition was presumably centrally determined. Reflex inhibition of opening by sensory stimulation which evokes closing

has been observed several times in Potamon (see section 5.97). As was indicated in section 5.10(2), this inhibition might have been effected either centrally, or peripherally via the opener and/or common inhibitor axon(s). Clearly, further experiments are required.

#### 6.5 Functional significance of peripheral inhibition in Decapod Crustacea.

Assuming, as has been tentatively concluded, that the adaptation of the reflex response of claw opening is not effected peripherally, either in Potamon or in Astacus, but is effected centrally in both, albeit by different central mechanisms, then it is to be expected that this adaptation is effected centrally in all Brachyura and Astacura, and probably, therefore, in all Decapoda Reptantia in which this reflex occurs. If this is so, then clearly a functional significance of peripheral inhibitor axon inhibition in the Crustacea is not to be found in peripheral control and adaptation of reflex responses. Other theories on the functional significance of peripheral inhibition must therefore be considered.

Wierans and Ripley (1952) suggested that the specific inhibitor axons of the limb muscles of the Decapod Crustacea are primarily to subserve locomotion, by giving freedom, in different ways and degrees in the different tribes, from the restriction imposed upon locomotion by the presence of the common opener-stretcher motor axon. Careful observations of the way in which the animals walk, and in particular, of the functional order and mode in which the individual muscles are used, would give some indication of the extent to which they do use the opener and stretcher muscles independently, and might suggest further specific functions of the individual inhibitor axons. Furthermore, it is conceivable that the different inhibitor axon supplies of the Astacura and Brachyura are related to the different modes of walking.

sideways in the Brachyura as opposed to forwards in the Astacura and other tribes of the Decapoda. Here again, careful observations of the modes of locomotion will help.

It is further suggested by Wiersma and Ripley that the individual inhibitor axons evolved from some condition in which there was only a common inhibitor axon. This common inhibitor was itself not used in normal locomotory movements, but functioned only during moulting, and possibly also in "possum-playing" (Wiersma, 1953), its role in moulting being "to block reflex contractions resulting from the sensory bombardment of the central nervous system at this critical time of the animal's life". It seems possible that the individual inhibitors evolved in the first place as a result of their advantage in walking locomotion. It will be of interest in this connection to learn more of the inhibitory innervations of the limbs of the Natantia and the Amphipodan.

Katz (1949) suggested that peripheral inhibition might serve to bring about graded relaxations of the muscles innervated, by a balance of inhibitory and motor impulses. Mantin (1936) suggested that peripheral inhibition serves to bring to an end contractions of the muscles innervated which are evoked by the BCK effect acting upon a constant background discharge in the motor fibres. Both these theories could reasonably be expected to apply only to the individual inhibitors, while in use during locomotion and obeliped activity; another explanation would be required to account for the common inhibitors. The absence of specific inhibitors in the muscles which lack them makes these theories rather improbable.

The original theory on the significance of peripheral inhibition was that it was to bring about reciprocal inhibition of antagonistic limb muscles. This theory, insofar as it implied that this occurred in all the

limb muscles, is untenable in view of the anatomical relations of the axons, which have since been worked out.

From the experiments described in sections 5.92 and 5.93, and discussed in section 5.10(2), the possibility arises, without experimental evidence either for or against it, that the main function of the opener inhibitor axon is to inhibit opening when closing is reflexly evoked, the opener inhibition being reflexly evoked by the same sensory stimulus as evokes closing. If this were so, then it might be that all the individual inhibitor axons of the limbs of the Decapod Crustacea have similar functions, namely to inhibit contractions of the muscles which they innervate when antagonistic muscles are reflexly activated; that is, reciprocal reflex inhibition. Clearly this function could only be of use in the muscles innervated by the individual inhibitors, since the common inhibitor would inhibit all the muscles. It may well be that locomotion in the Decapoda, in particular walking locomotion, is dependent, in its particular character, upon such a function of the individual inhibitor axons. Thus it is conceivable that the different inhibitor axon innervation patterns amongst the Decapoda/<sup>Reptantia</sup> evolved in relation to the different modes of locomotion, in a manner determined by this reciprocal reflex inhibitory function of these axons. This does not, however, preclude the possibility suggested by Wiereza and Ripley, that the individual inhibitors circumvented the restrictions imposed upon locomotion by the common opener-stretcher motor axon.

### 3.6 General Conclusion.

It is tentatively concluded that adaptation of reflex claw opening is not effected at the neuro-muscular-junctions, either in Potamon or in Astacus, but is effected centrally at the synapses of the claw opening reflex

system. From what little experimental evidence there is on the nature of this adaptation, it is suggested that, in Potamon, the opener inhibitor or common inhibitor axons are not involved in the adaptation, this being affected by pregressive inhibition at the central synapses of the opener motor axon; in Astacus, however, the opener inhibitor axon is evidently involved in the adaptation, this being affected by progressive facilitation of the central synapses of the opener inhibitor axon. It is a moot point as to whether a difference involving physiological properties as different as those here postulated could exist between two tribes, the Astacura and Brachyura, of a single Crustacean order, the Decapoda. It is most improbable that such a difference would exist between two taxonomical groups of less than ordinal rank.

In view of the first conclusion, it is further concluded, tentatively, that an explanation of the functional, biological significance of peripheral inhibitor axon inhibition in the Crustacea is not to be found in the theory that neuro-muscular-junctional inhibition interacts with n-n-j excitation to control adaptation and other variations of reflex muscle responses. It is likely, rather, that the significance of peripheral inhibition by the individual inhibitor axons is to be found in reflex activity involved in the locomotory mechanisms, in particular in walking locomotion in the Decapod Crustacea. It is possible, furthermore, that these inhibitors function in locomotion by reflexly inhibiting motor activity which is antagonistic to the succeeding reflexly-evoked motor activity. Peripheral inhibition by the common inhibitor axons probably has a more basic significance, as suggested by Wiersma and Ripley (1952), such as in moulting or "posture-playing".

9.0 <sup>154.</sup>  
SUMMARY.

1. The fresh-water crab, Potamon perlatus (Milne Edwards), has been used in a preliminary study of adaptation of reflex opening of the claws in response to sensory stimulation of various forms. During this study an attempt has been made to repeat the experiments of Hoffmann (1914), who, working on the fresh-water crayfish, Astacus fluviatilis Linn., found that reflex claw opening became adapted to prolonged or repeated sensory stimuli, but that, when the opener inhibitor axon of the claw was transected, the response did not become adapted. Furthermore, if the opener motor axon was transected and stimulated peripherally, the opener contraction evoked by this stimulus could be reflexly inhibited by sensory stimuli.

2. A mechanical hammer stimulator ("titillator") for applying sensory stimuli to any part of the body, was built from a Du-Bois Raymond induction coil. An electronic square-wave repetitive-pulse stimulator, modified after Bernstein (1950) and Ripley, was built for stimulating nerve bundles and single axons. An electrode micro-manipulator was built from parts of a microscope.

3. The anatomy and functions of the motor and inhibitor axons innervating the four most distal muscles of the chelipeds and walking legs of P. perlatus, and the anatomy only of the three muscles in the merus, have been established. The motor innervation pattern of P. perlatus was thus found to be similar in all major investigated respects to that of other Brachyura studied (c.f. Wiersma and Ripley, 1952).

4. For the experiments on reflex claw opening, the crab was mounted upside down on a specially constructed mounting board, with its abdomen held open for stimulating. Mechanical stimulation of the abdomen with the titillator was found to be the best form of sensory stimulation to evoke reflex claw opening.

5. The reflex claw opening response frequently disappeared during dissection and separation of the opener axons. Appropriate experiments indicated that motor fatigue and antidromic depression of 'central excitatory state' might have been partially responsible

for this, but that cerebral inhibition was probably not involved. Cooling the crab before an experiment was found to minimise this response disappearance.

6. No consistent adaptation or other effects of reflex claw opening in response to long duration mechanical sensory stimulation were found.

7. There was a clearcut adaptation of the mechanical responses of reflex claw opening to heavy repeated sensory stimuli to the outside surface of the abdomen, applied with the plasticene hammer-head on the titillator. This adaptation varied directly, both with the stimulus repetition frequency and with the duration of the individual stimuli. No consistent or significant differences in this adaptation were found between claws in which the specific opener inhibitor axon and/or the common inhibitor axon were left intact, and claws in which one or both of these inhibitors were transected. Peripheral opener inhibition was therefore not involved in this adaptation. Experimental evidence was given to show that this mechanical response adaptation was not due to motor fatigue, but that it was due mainly to sensory adaptation. Central nervous inhibitor influence was sometimes also apparent, particularly with lighter sensory stimuli.

8. A different form of adaptation, less clearcut or consistent, occurred in reflex claw opening responses to light repeated mechanical sensory stimuli to the tip of the abdomen, applied with the bare end of the titillator hammer rod. The results of four experiments in which light sensory stimulation of this kind was used, and of four other experiments using other forms of light mechanical repeated sensory stimuli, indicated that central nervous inhibitory control was largely responsible for this adaptation, and for other variations which occurred in the mechanical responses. In these eight experiments the opener inhibitor and motor axons were all intact. In one critical experiment of the first of these two series, the opener and common inhibitor axons were transected; there was no significant difference between the clearcut adaptation before inhibitor transection and that after transection. Thus reflexly evoked peripheral opener inhibition was probably not involved in

adaptation of reflex claw opening responses to light repeated mechanical sensory stimuli.

9. In three out of four experiments in which the opener motor axon was transected and stimulated peripherally, the opener contraction thus evoked was slightly inhibited by titillator sensory stimuli to the abdomen, applied for short periods during the motor stimulus. In the fourth record there was no inhibition at all. In four other experiments, in which the opener motor axon remained intact, the closer tendons being intact, strong inhibition of claw opening occurred in response to stroking the cutting edge of the claw. This indicated that simple reflex inhibition via the opener and/or common inhibitor axons did not commonly occur to any great extent, and that any 'reflex' inhibition that might occur was mainly centrally determined.

10. It was concluded from the experiments with mechanical sensory stimulation, (1) that the opener or common inhibitor axons are not involved in effecting adaptation of the mechanical responses of reflex claw opening to repeated sensory stimuli; (2) that this mechanical adaptation was effected mainly by sensory adaptation when the sensory stimuli were strong; and (3) that with light sensory stimuli the mechanical adaptation was effected mainly centrally. Further, three 'levels' of central control of adaptation to light sensory <sup>stimuli</sup> were postulated :

(a) rapid and clearcut mechanical adaptation to low sensory excitation, effected by increasing central inhibition of the reflex excitation;  
 (b) constant height responses, with no mechanical adaptation, resulting from medium sensory excitation, and effected by a balance of central excitation and central inhibition; and (c) slight decrease in the height of fairly strong responses to high central excitation, resulting from slowly decreasing central excitation : this borders on sensory adaptation resulting from heavy sensory stimulation.

11. In searching for suitable sensory stimuli to evoke reflex claw opening, three forms of electrical stimulation were found to evoke claw opening : abdominal, localised rostral, and ~~and~~ general rostral stimulation. No claw opening responses could be evoked by direct stimulation of the abdominal nerves.

12. Abdominal electrical stimulation, with the high voltages

(30-50 volts) usually required to evoke any claw opening responses at all, produced no consistent response variation effects. The responses obtained were attributed to general unspecific stimulation of the central nervous system, and possibly also of various elements of the efferent nervous system, resulting from spread of the electrical potential from the point of stimulation on the abdomen to the body. Strong central inhibition was sometimes manifested in post-stimulus responses.

13. With localised rostral stimulation, relatively low voltages (8-20 volts) were sometimes effective in evoking fairly clearcut claw opening responses. These responses were attributed to a direct stimulatory effect on the cheliped ganglion. Certain post-stimulus responses were attributed to release from central inhibition. Higher voltages were, however, usually required, and these had general and inconsistent effects on the nervous system, not unlike the effects of abdominal electrical stimulation.

14. General rostral stimuli of 10-50 volts, with the cathode on the rostrum, usually caused opening of both claws when the anode was on the soft inside surface of the abdomen, or closing of the anode-ipsilateral claw and opening of the anode-contralateral claw when the anode was placed in the basal socket or opened merus of one claw. These responses were attributed to a direct stimulatory effect on the opener and closer motor and inhibitory axons, the differential effects resulting from differential axonal thresholds. Lifting the opener motor axon out of the fluid in the merus of a claw localised the electrical excitation on the axon, this resulting in large, clearcut opening responses to the rostral stimuli. Effects of stimulation of the central nervous system were also observed. The results of these experiments on Potamon perlatum were comparable with those of other workers on other Crustacea.

15. In a few preliminary experiments, unilateral or bilateral cerebral ganglion elimination, by transection of one or both circumoesophageal commissures, resulted in greater locomotor and scaphgnite activity on the operated side(s). This was attributed to the inhibitory influence of the cerebral ganglion on the thoracic ganglia, and is comparable with similar results of other workers on various Crustacea and Insecta.

16. The main conclusions on the nature of the adaptation of reflex claw opening in Potamon were discussed, in relation to the conclusions of Hoffmann (1914) on the adaptation of the same reflex in Astacus. A possible explanation was suggested for the apparent difference, in the mechanism of this adaptation, between Potamon and Astacus. The significance of peripheral inhibition in the Decapod Crustacea was discussed in the light of the conclusions of the present work.

#### ACKNOWLEDGEMENTS.

I wish to express my appreciation to my supervisor, Professor D.W. Dwer, for his stimulating criticism and advice during the present research, and to Dr. S.H. Ripley and members of the Zoology Departments of Rhodes and Natal Universities and of the Physics Department of Rhodes University, for their valuable technical aid and suggestions.

This work was carried out during tenure of a bursary awarded by the Council for Scientific and Industrial Research, to whom I am grateful.

REFERENCES.

- BARONSTEIN, L. 1950. An electronic square-wave stimulator. *J. Physiol.* 111, 34P.
- x BÄTKE, A. 1897. (On the function of the central nervous system of arthropods.) *Pflug. Arch. ges. Physiol.* 68, 449.
- x BINDERMANN, W. 1887. (On the innervation of skeletal musculature of arthropods.) *Sitzungsber. d. K. Akad. Wiss. Wien* 96, (3), Juni.
- GREEN, R. D., DENNY-BROWN, D., HOLMES, J. C., LIDDELL, R. G. Y., and SHERRINGTON, C. S. Reflex Activity of the Spinal Cord. 1932. Oxford Univ. Press.
- x DUVAL, A. 1925. (Quoted in KROGH, A. 1939. Osmotic Regulation in Aquatic Animals. Cambridge Univ. Press.)
- SWER, D. W. 1951. Physiology and phylogeny. *S. Afr. J. Sci.* 48, 115.
- HOFFMANN, P. 1914. Über die doppelte Innervation der Krebsmuskeln. Zugleich ein Beitrag zur Kenntnis nervöser Nennungen. *Z. f. Biol.* 53, 411.
- HOYLE, G. 1955. Neuro-muscular mechanisms of a locust skeletal muscle. *Proc. Roy. Soc. B.* 145, 343.
- HUGHES, G. W. 1953. Differential effects of direct current on insect ganglia. *J. Exp. Biol.* 29, 387.
- KATZ, B. 1949. Neuro-muscular transmission in invertebrates. *Biol. Rev.* 24, 1.
- x LOEW, J. and MAXWELL, S. S. 1896. Zur Theorie des Galvanotropismus. *Pflug. Arch. ges. Physiol.* 63, 121.
- MAHMONT, G. and WIEREMA, C. A. G. 1938. On the mechanism of inhibition and excitation of crayfish muscle. *J. Physiol.* 93, 173.
- x MILLER, F. R. 1907. Galvanotropism in the crayfish. *J. Physiol.* 35, 215.
- PASTIN, G. F. A. 1934. On the excitation of crustacean muscle. I. *J. Exp. Biol.* 11, 11.
1935. On the excitation of crustacean muscle. II. *Ibid.* 13, 159.
1948. Notes on microscopical technique for zoologists. Cambridge Univ. Press.
- PRINGLE, J. W. S. 1940. The reflex mechanism of the insect leg. *J. Exp. Biol.* 17, 8.
- PROSSER, C. L. 1935. Functional tracts in the nervous system of the crayfish. *J. Comp. Neurol.* 52, 495.
- ROGGER, K. B. 1935. *Insect Physiology.*

- x SCHEMINSKY, F. 1943. Stromwirkung und Feinstruktur im Zentralnervensystem. *Naturwissenschaften*, 31, 388.
- SHIFF, C. and SWER, D.W. 1952. Perfusion fluid for *Potamon sidaxvi*. *S.Afr.J.Sci.* 51.
- SCHLATTER, M.J. 1941. *J.Cell.Comp.Physiol.* 17, 289. (Quoted in Pantin, 1948.)
- SCHLIEPPE, and HERMANN, 1930.
- Van HANREVELD, A. 1936. A physiological saline solution for the crayfish. *Proc.Soc.Exp.Biol.Med.* 34, 426.
- Van HANREVELD, A. and WIJNSMA, C.A.G. 1936. The double motor innervation of the adductor muscle of the claw of the crayfish. *J.Physiol.* 88, 78.
- WIJNSMA, C.A.G. 1933. Vergleichende Untersuchungen über das periphere Nerven-Muskelsystem von Crustaceen. *Z.Vergleich.Physiol.* 12, 349.
1941. The inhibitory nerve supply of the leg muscles of different Decapod Crustaceans. *J.Comp.Neurol.* 24, 63.
1951. A bifunctional single motor axon system of a crustacean muscle. *J.Exp.Biol.* 22, 13.
1953. Neural transmission in invertebrates. *Physiol.Rev.* 33, 326.
- WIJNSMA, C.A.G. and RIPLEY, E.H. 1952. Innervation patterns of crustacean limbs. *Physiol.Comp.et Geol.* 2, 391.
- WIJNSMA, C.A.G. and Van HANREVELD, A. 1938. A comparative study of the double motor innervation in marine Crustacea. *J.Exp.Biol.* 15, 18.

( x - Not seen in the original.)